



**TRENDNET**®



User's Guide

**TWG-BRF114**

# Table of Contents

---

<b>CHAPTER 1 INTRODUCTION .....</b>	<b>3</b>
Broadband Router Features.....	2
Package Contents .....	3
Physical Details.....	4
<b>CHAPTER 2 INSTALLATION.....</b>	<b>6</b>
Requirements.....	6
Procedure.....	7
<b>CHAPTER 3 SETUP .....</b>	<b>8</b>
Overview .....	8
Configuration Program .....	9
Setup Wizard .....	11
LAN Screen.....	14
Password Screen.....	16
<b>CHAPTER 4 PC CONFIGURATION .....</b>	<b>16</b>
Overview .....	16
Windows Clients.....	16
Macintosh Clients.....	32
Linux Clients.....	32
Other Unix Systems.....	32
<b>CHAPTER 5 OPERATION AND STATUS.....</b>	<b>33</b>
Operation .....	33
Status Screen.....	33
Connection Details - Fixed/Dynamic IP Address .....	34
Connection Status - PPPoE .....	36
Connection Status - PPTP .....	38
Connection Status - L2TP.....	39
Connection Status - Telstra Big Pond.....	40
Connection Details - SingTel RAS .....	42
<b>CHAPTER 6 ADVANCED FEATURES .....</b>	<b>43</b>
Overview .....	43
Access Control .....	43
Dynamic DNS (Domain Name Server) .....	49
Advanced Internet Screen .....	51
URL Filter.....	55
Define Schedule .....	57
User Groups.....	58
Virtual Servers.....	59
WAN Port Configuration .....	62
<b>CHAPTER 7 ADVANCED ADMINISTRATION .....</b>	<b>64</b>
Overview .....	64
Config File.....	66
Logs.....	67
Network Diagnostics .....	69
Options .....	70
PC Database.....	71
Remote Admin .....	75
Routing .....	76
Security.....	80
Upgrade Firmware .....	82

<b>APPENDIX A TROUBLESHOOTING .....</b>	<b>1</b>
<b>Overview .....</b>	
<b>General Problems .....</b>	
<b>Internet Access.....</b>	<b>83</b>
<b>APPENDIX B SPECIFICATIONS.....</b>	<b>83</b>
<b>Multi-Function Broadband Router .....</b>	<b>83</b>
<b>Regulatory Approvals .....</b>	<b>85</b>

P/N: 9560S80001

Copyright © 2005. All Rights Reserved.

Document Version: 1.0 (April, 2005)

All trademarks and trade names are the properties of their respective owners.

## Chapter 1

# Introduction

*This Chapter provides an overview of the Broadband Router's features and capabilities.*

Congratulations on the purchase of your new Broadband Router. The Broadband Router is a multi-function device providing the following services:



- **Shared Broadband Internet Access** for all LAN users.
- **4-Port Switching Hub** for 10BaseT or 100BaseT connections.

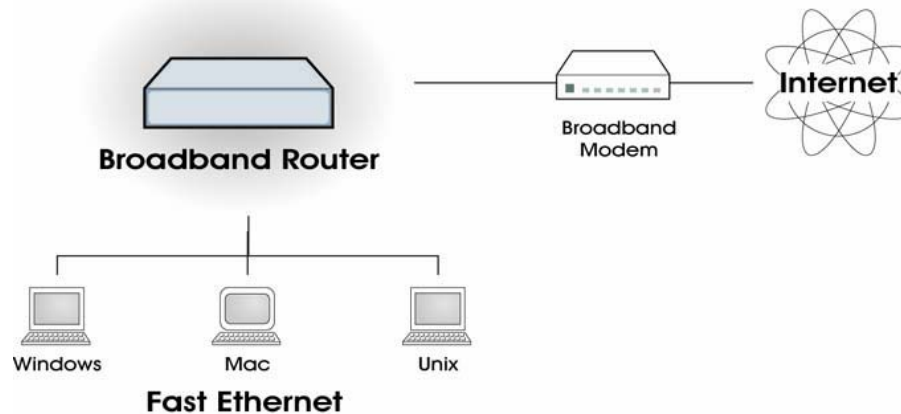

Figure 1: Broadband Router

## Broadband Router Features

The Broadband Router incorporates many advanced features, carefully designed to provide sophisticated functions while being easy to use.

### Internet Access Features

- **Shared Internet Access.** All users on the LAN or WLAN can access the Internet through the Broadband Router, using only a single external IP Address. The local (invalid) IP Addresses are hidden from external sources. This process is called NAT (Network Address Translation).
- **DSL & Cable Modem Support.** The Broadband Router has a 10/100/1000BaseT Ethernet port for connecting a DSL or Cable Modem. All popular DSL and Cable Modems are supported. SingTel RAS and Big Pond (Australia) login support is also included.
- **PPPoE, PPTP, SingTel RAS and Telstra Big Pond Support.** The Internet (WAN port) connection supports PPPoE (PPP over Ethernet), PPTP (Peer-to-Peer Tunneling Protocol), SingTel RAS and Telstra Big Pond (Australia), as well as "Direct Connection" type services.
- **Fixed or Dynamic IP Address.** On the Internet (WAN port) connection, the Broadband Router supports both Dynamic IP Address (IP Address is allocated on connection) and Fixed IP Address.

### Advanced Internet Functions

- **Communication Applications.** Support for Internet communication applications, such as interactive Games, Telephony, and Conferencing applications, which are often difficult to use when behind a Firewall, is included.
- **Special Internet Applications.** Applications which use non-standard connections or port numbers are normally blocked by the Firewall. The ability to define and allow such applications is provided, to enable such applications to be used normally.
- **Virtual Servers.** This feature allows Internet users to access Internet servers on your LAN. The required setup is quick and easy.
- **DMZ.** One (1) PC on your local LAN can be configured to allow unrestricted 2-way communication with Servers or individual users on the Internet. This provides the ability to run programs which are incompatible with Firewalls.
- **URL Filter.** Use the URL Filter to block access to undesirable Web sites by LAN users.
- **Internet Access Log.** See which Internet connections have been made.
- **Access Control.** Using the Access Control feature, you can assign LAN users to different groups, and determine which Internet services are available to each group.

- **VPN Pass through Support.** PCs with VPN (Virtual Private Networking) software using PPTP, L2TP and IPSec are transparently supported - no configuration is required.

## LAN Features

- **4-Port Switching Hub.** The Broadband Router incorporates a 4-port 10/100/1000BaseT switching hub, making it easy to create or extend your LAN.
- **DHCP Server Support.** Dynamic Host Configuration Protocol provides a dynamic IP address to PCs and other devices upon request. The Broadband Router can act as a **DHCP Server** for devices on your local LAN and WLAN.
- **Multi Segment LAN Support.** LANs containing one or more segments are supported, via the Broadband Router's RIP (Routing Information Protocol) support and built-in static routing table.

## Configuration & Management

- **Easy Setup.** Use your WEB browser from anywhere on the LAN for configuration.
- **Configuration File Upload/Download.** Save (download) the configuration data from the Broadband Router to your PC, and restore (upload) a previously-saved configuration file to the Broadband Router.
- **Remote Management.** The Broadband Router can be managed from any PC on your LAN. And, if the Internet connection exists, it can also (optionally) be configured via the Internet.
- **UPnP Support.** UPnP (Universal Plug and Play) allows automatic discovery and configuration of the Broadband Router. UPnP is supported by Windows ME, XP, or later.

## Security Features

- **Password - protected Configuration.** Optional password protection is provided to prevent unauthorized users from modifying the configuration data and settings.
- **NAT Protection.** An intrinsic side effect of NAT (Network Address Translation) technology is that by allowing all LAN users to share a single IP address, the location and even the existence of each PC is hidden. From the external viewpoint, there is no network, only a single device - the Broadband Router.
- **Stateful Inspection Firewall.** All incoming data packets are monitored and all incoming server requests are filtered, thus protecting your network from malicious attacks from external sources.
- **Protection against DoS attacks.** DoS (Denial of Service) attacks can flood your Internet connection with invalid packets and connection requests, using so much bandwidth and so many resources that Internet access becomes unavailable. The Broadband Router incorporates protection against DoS attacks.

## Package Contents

The following items should be included:

- The Broadband Router Unit
- Power Adapter
- Quick Installation Guide
- CD-ROM containing the on-line manual.

If any of the above items are damaged or missing, please contact your dealer immediately.

## Physical Details

### Front-mounted LEDs

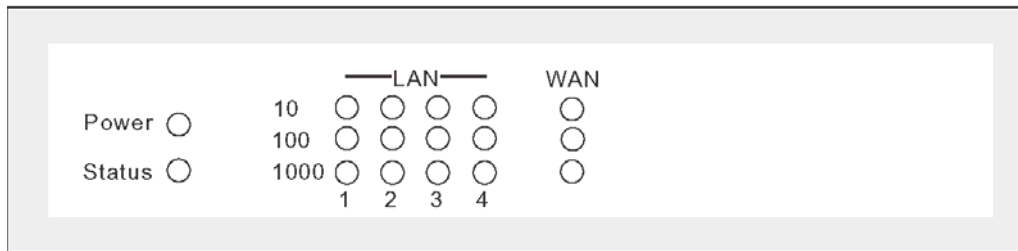

**Figure 2: Front Panel**

- Power**      **On** - Power on.  
**Off** - No power.
- Status (Red)**      **On** - Error condition.  
**Off** - Normal operation.  
**Blinking** - This LED blinks during start up.
- LAN**      For each port, there are 3 LEDs
- **10**
    - **On** - Corresponding LAN (hub) port is active.
    - **Off** - No active connection on the corresponding LAN (hub) port.
    - **Flashing** - Data is being transmitted or received via the corresponding LAN (hub) port.
  - **100**
    - **On** - Corresponding LAN (hub) port is using 100BaseT.
    - **Off** - No active connection on the corresponding LAN (hub) port.
    - **Flashing** - Data is being transmitted or received via the corresponding LAN (hub) port.
  - **1000**
    - **On** - Corresponding LAN (hub) port is using 1000BaseT.
    - **Off** - No active connection on the corresponding LAN (hub) port.
    - **Flashing** - Data is being transmitted or received via the corresponding LAN (hub) port.

**WAN**

- **10**
  - **On** - Connection to the broadband modem attached to the WAN (Internet) port is established.
  - **Off** - No connection to the broadband modem on the WAN (internet) port.
  - **Flashing** - Data is being transmitted or received via the WAN port.
- **100**
  - **On** - Corresponding WAN (hub) port is using 100BaseT.
  - **Off** - No connection to the broadband modem on the WAN (internet) port.
  - **Flashing** - Data is being transmitted or received via the WAN port.
- **1000**
  - **On** - Corresponding WAN (Internet) port is using 1000BaseT.
  - **Off** - No active connection on the corresponding WAN (Internet) port.
  - **Flashing** - Data is being transmitted or received via the WAN port.

## Rear Panel

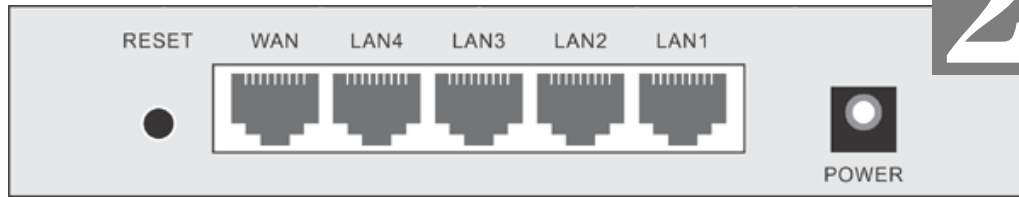

**Figure 3: Rear Panel**

### Reset Button

This button has two (2) functions:

- **Reboot.** When pressed and released, the Broadband Router will reboot (restart).
- **Clear All Data.** This button can also be used to clear ALL data and restore ALL settings to the factory default values.

#### To Clear All Data and restore the factory default values:

1. Power Off.
2. Hold the Reset Button down while you Power On.
3. Keep holding the Reset Button for a few seconds, until the RED LED has flashed TWICE.
4. Release the Reset Button. The Broadband Router is now using the factory default values.

### WAN port (10/100/1000BaseT)

Connect the DSL or Cable Modem here. If your modem came with a cable, use the supplied cable. Otherwise, use a standard LAN cable.

### 10/100/1000BaseT LAN connections

Use standard LAN cables (RJ45 connectors) to connect your PCs to these ports.

#### Note:

Any LAN port on the Broadband Router will automatically function as an "Uplink" port when required. Just connect any port to a normal port on the other hub, using a standard LAN cable.

### Power port

Connect the supplied power adapter here.

## Chapter 2

# Installation

*This Chapter covers the physical installation of the Broadband Router.*

## Requirements

- Network cables. Use standard 10/100/1000BaseT network (UTP) cables with RJ45 connectors.
- TCP/IP protocol must be installed on all PCs.
- For Internet Access, an Internet Access account with an ISP, and either of a DSL or Cable modem (for WAN port usage)



## Procedure

# 3

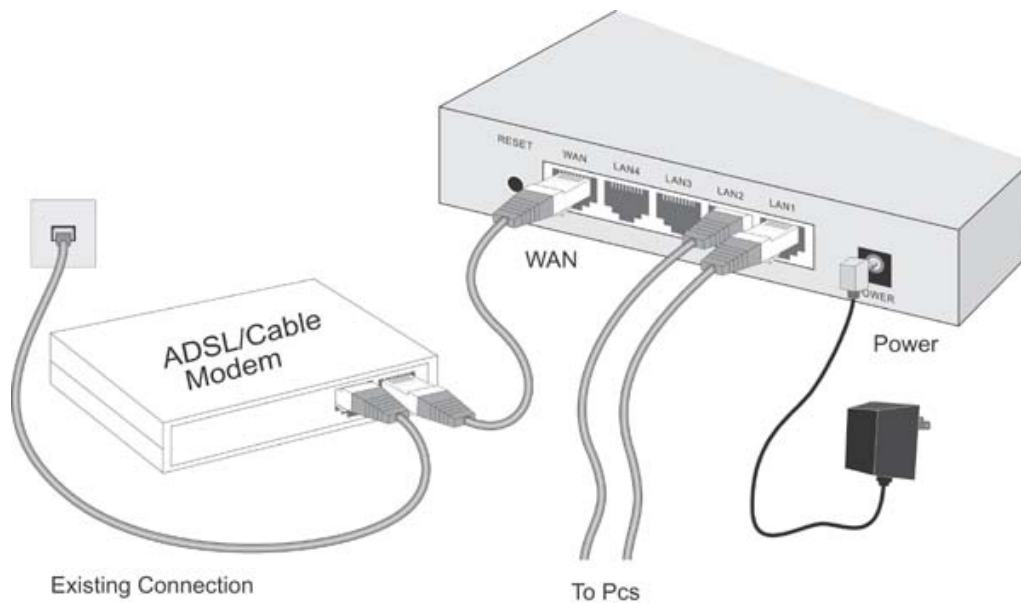

**Figure 4: Installation Diagram**

### 1. Choose an Installation Site

Select a suitable place on the network to install the Broadband Router. Ensure the Broadband Router and the DSL/Cable modem are powered OFF.

### 2. Connect LAN Cables

Use standard LAN cables to connect PCs to the Switching Hub ports on the Broadband Router. Both 10BaseT and 100BaseT connections can be used simultaneously.

If required, connect any port to a normal port on another Hub, using a standard LAN cable. Any LAN port on the Broadband Router will automatically function as an "Uplink" port when required.

### 3. Connect WAN Cable

Connect the DSL or Cable modem to the WAN port on the Broadband Router. Use the cable supplied with your DSL/Cable modem. If no cable was supplied, use a standard cable.

### 4. Power Up

- Power on the Cable or DSL modem.
- Connect the supplied power adapter to the Broadband Router and power up. Use only the power adapter provided. Using a different one may cause hardware damage

### 5. Check the LEDs

- The *Power* LED should be ON.
- The *Status* LED should flash, then turn Off. If it stays on, there is a hardware error.
- For each LAN (PC) connection, the LAN *Link/Act* LED should be ON (provided the PC is also ON.)
- The *WAN* LED should be ON.

For more information, refer to Front-mounted LEDs in Chapter 1.

# Chapter 3

## Setup

*This Chapter provides Setup details of the Broadband Router.*

### Overview

This chapter describes the setup procedure for:

- Internet Access
- LAN configuration
- Assigning a Password to protect the configuration data.

PCs on your local LAN may also require configuration. For details, see *Chapter 4 - PC Configuration*.

Other configuration may also be required, depending on which features and functions of the Broadband Router you wish to use. Use the table below to locate detailed instructions for the required functions.

To Do this:	Refer to:
Configure PCs on your LAN.	Chapter 4: PC Configuration
Check Broadband Router operation and Status.	Chapter 5: Operation and Status
Use any of the following Advanced features: <ul style="list-style-type: none"> <li>• Access Control</li> <li>• Dynamic DNS</li> <li>• Internet</li> <li>• Virtual Servers</li> <li>• WAN Port</li> </ul>	Chapter 6: Advanced Features
Use any of the following Administration Configuration settings or features: <ul style="list-style-type: none"> <li>• Config File</li> <li>• Logs</li> <li>• Network Diag</li> <li>• Options</li> <li>• PC Database</li> <li>• Remote Admin</li> <li>• Routing</li> <li>• Security</li> <li>• Upgrade Firmware</li> </ul>	Chapter 7 Advanced Administration

## Configuration Program

The Broadband Router contains an HTTP server. This enables you to connect to it, and configure it, using your Web Browser. **Your Browser must support JavaScript.**

The configuration program has been tested on the following browsers:

- Netscape V4.08 or later
- Internet Explorer V4 or later

### Preparation

Before attempting to configure the Broadband Router, please ensure that:

- Your PC can establish a physical connection to the Broadband Router. The PC and the Broadband Router must be directly connected (using the Hub ports on the Broadband Router) or on the same LAN segment.
- The Broadband Router must be installed and powered ON.
- If the Broadband Router's default IP Address (192.168.0.1) is already used by another device, the other device must be turned OFF until the Broadband Router is allocated a new IP Address during configuration.

### Using UPnP

If your Windows system supports UPnP, an icon for the Broadband Router will appear in the system tray, notifying you that a new network device has been found, and offering to create a new desktop shortcut to the newly-discovered device.

- Unless you intend to change the IP Address of the Broadband Router, you can accept the desktop shortcut.
- Whether you accept the desktop shortcut or not, you can always find UPnP devices in *My Network Places* (previously called *Network Neighborhood*).
- Double - click the icon for the Broadband Router (either on the Desktop, or in *My Network Places*) to start the configuration. Refer to the following section *Setup Wizard* for details of the initial configuration process.

### Using your Web Browser

To establish a connection from your PC to the Broadband Router:

1. After installing the Broadband Router in your LAN, start your PC. If your PC is already running, restart it.
2. Start your WEB browser.
3. In the *Address* box, enter "HTTP://" and the IP Address of the Broadband Router, as in this example, which uses the Broadband Router's default IP Address:

HTTP://192.168.0.1

### **If you can't connect**

If the Broadband Router does not respond, check the following:

- The Broadband Router is properly installed, LAN connection is OK, and it is powered ON. You can test the connection by using the "Ping" command:
  - Open the MS-DOS window or command prompt window.
  - Enter the command:  
`ping 192.168.0.1`  
If no response is received, either the connection is not working, or your PC's IP address is not compatible with the Broadband Router's IP Address. (See next item.)
- If your PC is using a fixed IP Address, its IP Address must be within the range 192.168.0.2 to 192.168.0.254 to be compatible with the Broadband Router's default IP Address of 192.168.0.1. Also, the *Network Mask* must be set to 255.255.255.0. See *Chapter 4 - PC Configuration* for details on checking your PC's TCP/IP settings.
- Ensure that your PC and the Broadband Router are on the same network segment. (If you don't have a router, this must be the case.)

## Setup Wizard

The first time you connect to the Broadband Router, the Setup Wizard will run automatically. (The Setup Wizard will also run if the Broadband Router's default settings are restored.)

1. Step through the Wizard until finished.
  - You need to know the type of Internet connection service used by your ISP. Check the data supplied by your ISP.
  - The common connection types are explained in the tables below.
2. On the final screen of the Wizard, run the test and check that an Internet connection can be established.
3. If the connection test fails:
  - Check your data, the Cable/DSL modem, and all connections.
  - Check that you have entered all data correctly.
  - If using a Cable modem, your ISP may have recorded the MAC (physical) address of your PC. Run the Wizard, and on the *Cable Modem* screen, use the "Clone MAC address" button to copy the MAC address from your PC to the Broadband Router.

## Common Connection Types

### Cable Modems

Type	Details	ISP Data required
Dynamic IP Address	Your IP Address is allocated automatically, when you connect to your ISP.	Usually, none.  However, some ISP's may require you to use a particular Hostname, Domain name, or MAC (physical) address.
Static (Fixed) IP Address	Your ISP allocates a permanent IP Address to you.	IP Address allocated to you.  Some ISP's may also require you to use a particular Hostname, Domain name, or MAC (physical) address.

### DSL Modems

Type	Details	ISP Data required
Dynamic IP Address	Your IP Address is allocated automatically, when you connect to your ISP.	None.
Static (Fixed) IP Address	Your ISP allocates a permanent IP Address to you.	IP Address allocated to you.
PPPoE	You connect to the ISP only when required. The IP address is usually allocated automatically.	User name and password.



PPTP	<p>PPTP is mainly used in Europe.</p> <p>You connect to the ISP only when required. The IP address is usually allocated automatically, but may be Static (Fixed).</p>	<ul style="list-style-type: none"> <li>• Server Address.</li> <li>• User name and password.</li> <li>• IP Address allocated to you, if Static (Fixed).</li> </ul>
------	---	---

### Other Modems (e.g. Broadband Wireless)

Type	Details	ISP Data required
Dynamic IP Address	Your IP Address is allocated automatically, when you connect to you ISP.	None.
Static (Fixed) IP Address	Your ISP allocates a permanent IP Address to you.	IP Address allocated to you.

### Big Pond (Australia)

For this connection method, the following data is required:

- User Name
- Password
- Big Pond Server IP address

### SingTel RAS

For this connection method, the following data is required:

- User Name
- Password
- RAS Plan

## Home Screen

After finishing the Setup Wizard, you will see the *Home* screen. When you connect in future, you will see this screen when you connect. An example screen is shown below.

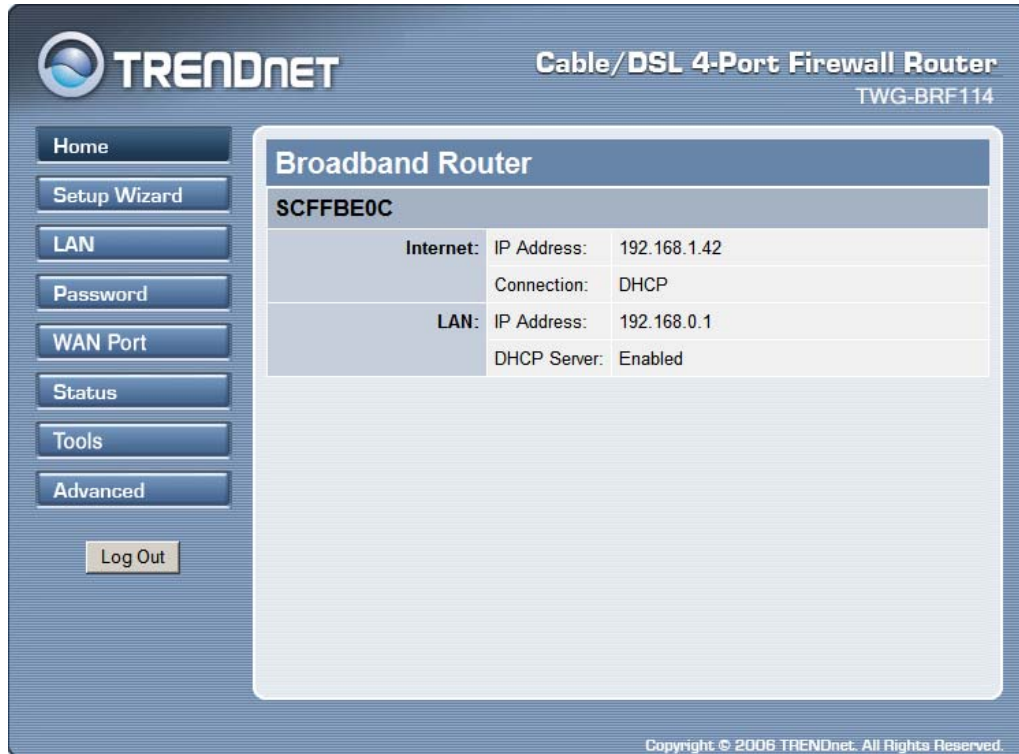

Figure 5: Home Screen

### Navigation & Data Input

- Use the menu bar on the left of the screen, and the "Back" button on your Browser, for navigation.
- Changing to another screen without clicking "Save" does NOT save any changes you may have made. You must "Save" before changing screens or your data will be ignored.



On each screen, clicking the "Help" button will display help for that screen.

From any help screen, you can access the list of all help files (help index).

## LAN Screen

Use the *LAN* link on the main menu to reach the *LAN* screen. An example screen is shown below.

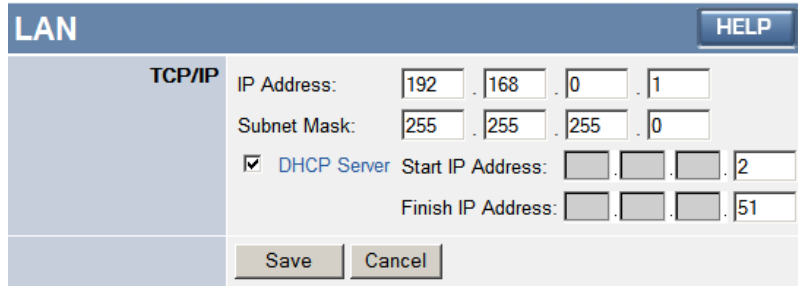

**Figure 6: LAN Screen**

### Data - LAN Screen

TCP/IP	
<b>IP Address</b>	IP address for the Broadband Router, as seen from the local LAN. Use the default value unless the address is already in use or your LAN is using a different IP address range. In the latter case, enter an unused IP Address from within the range used by your LAN.
<b>Subnet Mask</b>	The default value 255.255.255.0 is standard for small (class "C") networks. For other networks, use the Subnet Mask for the LAN segment to which the Broadband Router is attached (the same value as the PCs on that LAN segment).
<b>DHCP Server</b>	<ul style="list-style-type: none"> <li>• If Enabled, the Broadband Router will allocate IP Addresses to PCs (DHCP clients) on your LAN when they start up. The default (and recommended) value is Enabled.</li> <li>• If you are already using a DHCP Server, this setting must be Disabled, and the existing DHCP server must be re-configured to treat the Broadband Router as the default Gateway. See the following section for further details.</li> <li>• The <b>Start IP Address</b> and <b>Finish IP Address</b> fields set the values used by the DHCP server when allocating IP Addresses to DHCP clients. This range also determines the number of DHCP clients supported.</li> </ul> <p>See the following section for further details on using DHCP.</p>
Buttons	
<b>Save</b>	Save the data on screen.
<b>Cancel</b>	The "Cancel" button will discard any data you have entered and reload the file from the Broadband Router.

## DHCP

### What DHCP Does

A DHCP (Dynamic Host Configuration Protocol) **Server** allocates a valid IP address to a DHCP **Client** (PC or device) upon request.

- The client request is made when the client device starts up (boots).
- The DHCP Server provides the *Gateway* and *DNS* addresses to the client, as well as allocating an IP Address.

- The Broadband Router can act as a **DHCP server**.
- Windows 95/98/ME and other non-Server versions of Windows will act as a DHCP **client**. This is the default Windows setting for the TCP/IP network protocol. However, Windows uses the term *Obtain an IP Address automatically* instead of "DHCP Client".
- You must NOT have two (2) or more DHCP Servers on the same LAN segment. (If your LAN does not have other Routers, this means there must only be one (1) DHCP Server on your LAN.)

### Using the Broadband Router's DHCP Server

This is the default setting. The DHCP Server settings are on the **LAN** screen. On this screen, you can:

- Enable or Disable the Broadband Router's *DHCP Server* function.
- Set the range of IP Addresses allocated to PCs by the DHCP Server function.



**You can assign Fixed IP Addresses to some devices while using DHCP, provided that the Fixed IP Addresses are NOT within the range used by the DHCP Server.**

### Using another DHCP Server

You can only use one (1) DHCP Server per LAN segment. If you wish to use another DHCP Server, rather than the Broadband Router's, the following procedure is required.

1. Disable the DHCP Server feature in the Broadband Router. This setting is on the LAN screen.
2. Configure the DHCP Server to provide the Broadband Router's IP Address as the *Default Gateway*.

### To Configure your PCs to use DHCP

This is the default setting for TCP/IP under Windows 95/98/ME.

See *Chapter 4 - Client Configuration* for the procedure to check these settings.

## Password Screen

# 4

The password screen allows you to assign a password to the Broadband Router.

**Figure 7: Password Screen**

Once you have assigned a password to the Broadband Router (on the *Password* screen above) you will be prompted for the password when you connect, as shown below. (If no password has been set, this dialog will not appear.)

**Figure 8: Password Dialog**

- Leave the "User Name" blank.
- Enter the password for the Broadband Router, as set on the *Password* screen above.

## Chapter 4

# PC Configuration

*This Chapter details the PC Configuration required on the local ("Internal") LAN.*

## Overview

For each PC, the following may need to be configured:

- TCP/IP network settings
- Internet Access configuration

## Windows Clients

This section describes how to configure Windows clients for Internet access via the Broadband Router.



The first step is to check the PC's TCP/IP settings.

The Broadband Router uses the TCP/IP network protocol for all functions, so it is essential that the TCP/IP protocol be installed and configured on each PC.

## TCP/IP Settings - Overview

**If using the default Broadband Router settings, and the default Windows TCP/IP settings, no changes need to be made.**

- By default, the Broadband Router will act as a DHCP Server, automatically providing a suitable IP Address (and related information) to each PC when the PC boots.
- For all non-Server versions of Windows, the default TCP/IP setting is to act as a DHCP client.

**If using a Fixed (specified) IP address, the following changes are required:**

- The *Gateway* must be set to the IP address of the Broadband Router
- The *DNS* should be set to the address provided by your ISP.



**If your LAN has a Router, the LAN Administrator must re-configure the Router itself. Refer to *Chapter 8 - Advanced Setup* for details.**

## Checking TCP/IP Settings - Windows 9x/ME:

1. Select *Control Panel - Network*. You should see a screen like the following:

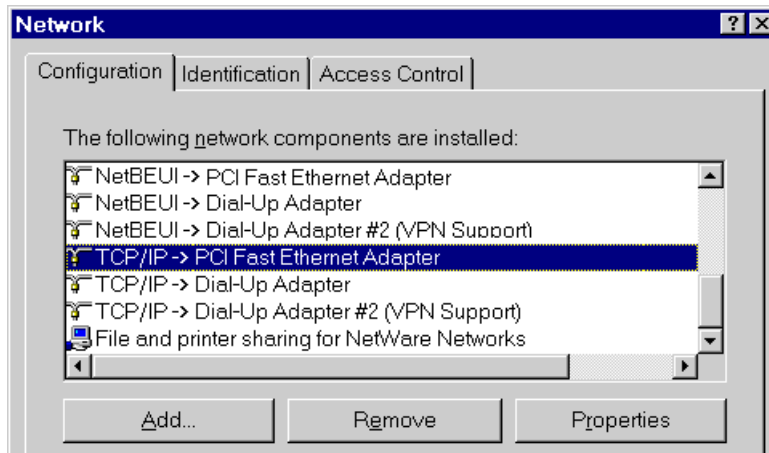

**Figure 9: Network Configuration**

2. Select the *TCP/IP* protocol for your network card.
3. Click on the *Properties* button. You should then see a screen like the following.

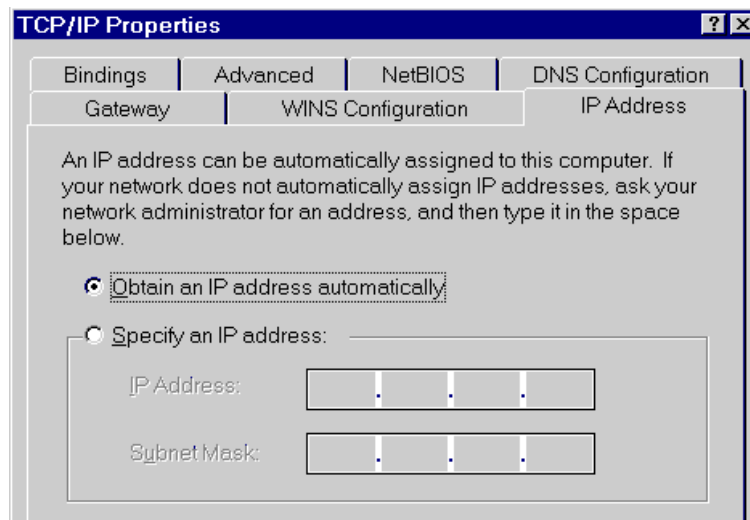

**Figure 10: IP Address (Win 95)**

Ensure your TCP/IP settings are correct, as follows:

### Using DHCP

To use DHCP, select the radio button *Obtain an IP Address automatically*. This is the default Windows setting. **Using this is recommended.** By default, the Broadband Router will act as a DHCP Server.

Restart your PC to ensure it obtains an IP Address from the Broadband Router.

### Using "Specify an IP Address"

If your PC is already configured, check with your network administrator before making the following changes:

- On the *Gateway* tab, enter the Broadband Router's IP address in the *New Gateway* field and click *Add*, as shown below. Your LAN administrator can advise you of the IP Address they assigned to the Broadband Router.

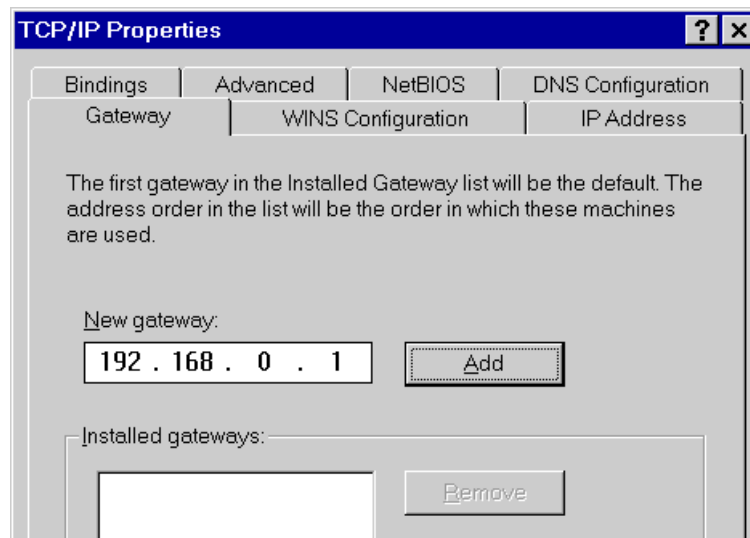

**Figure 11: Gateway Tab (Win 95/98)**

- On the *DNS Configuration* tab, ensure *Enable DNS* is selected. If the *DNS Server Search Order* list is empty, enter the DNS address provided by your ISP in the fields beside the *Add* button, then click *Add*.

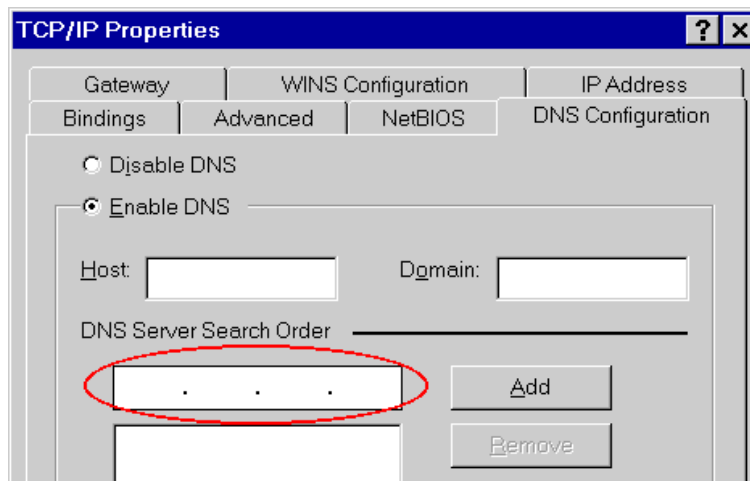

**Figure 12: DNS Tab (Win 95/98)**

## Checking TCP/IP Settings - Windows NT4.0

1. Select *Control Panel - Network*, and, on the *Protocols* tab, select the TCP/IP protocol, as shown below.

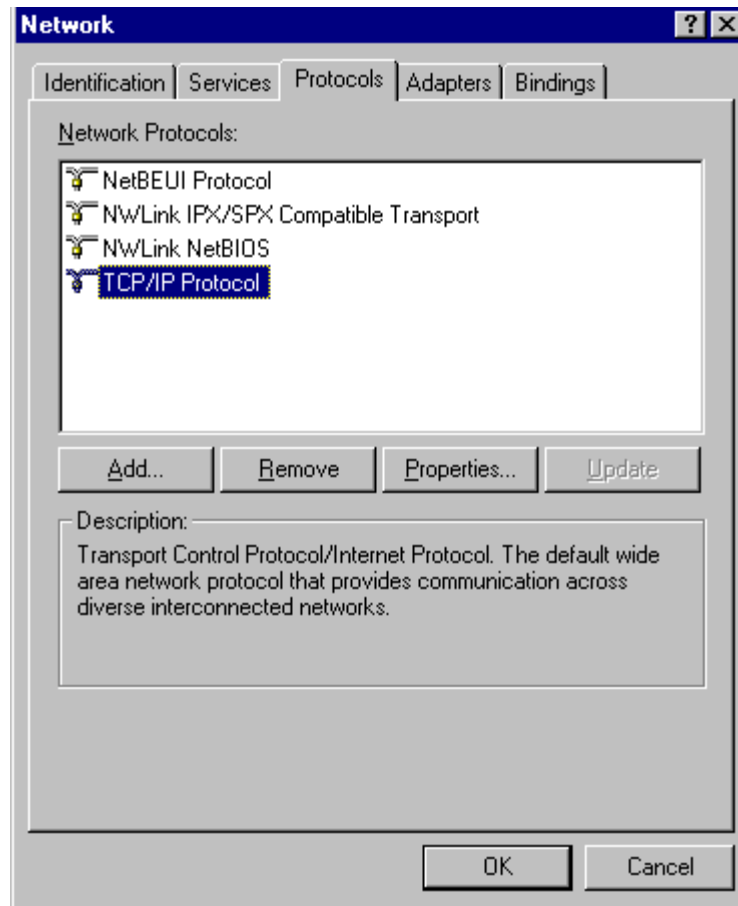

**Figure 13: Windows NT4.0 - TCP/IP**

2. Click the *Properties* button to see a screen like the one below.

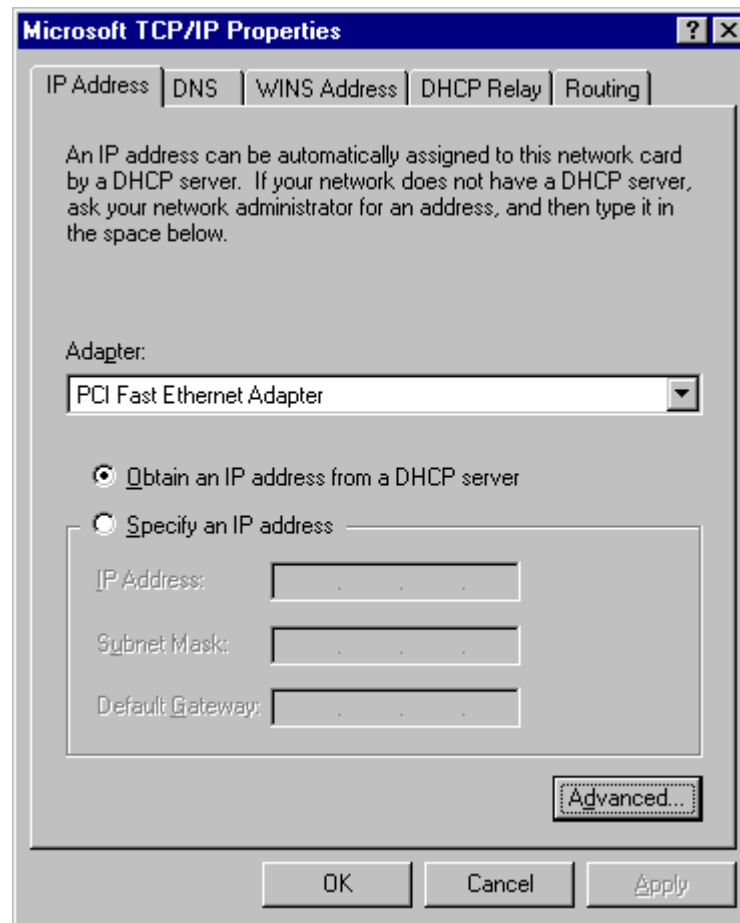

**Figure 14: Windows NT4.0 - IP Address**

3. Select the network card for your LAN.
4. Select the appropriate radio button - *Obtain an IP address from a DHCP Server* or *Specify an IP Address*, as explained below.

### **Obtain an IP address from a DHCP Server**

This is the default Windows setting. **Using this is recommended.** By default, the Broadband Router will act as a DHCP Server. Restart your PC to ensure it obtains an IP Address from the Broadband Router.

### **Specify an IP Address**

If your PC is already configured, check with your network administrator before making the following changes.

1. The *Default Gateway* must be set to the IP address of the Broadband Router. To set this:
  - Click the *Advanced* button on the screen above.
  - On the following screen, click the *Add* button in the *Gateways* panel, and enter the Broadband Router's IP address, as shown in Figure 15 below.
  - If necessary, use the *Up* button to make the Broadband Router the first entry in the *Gateways* list.



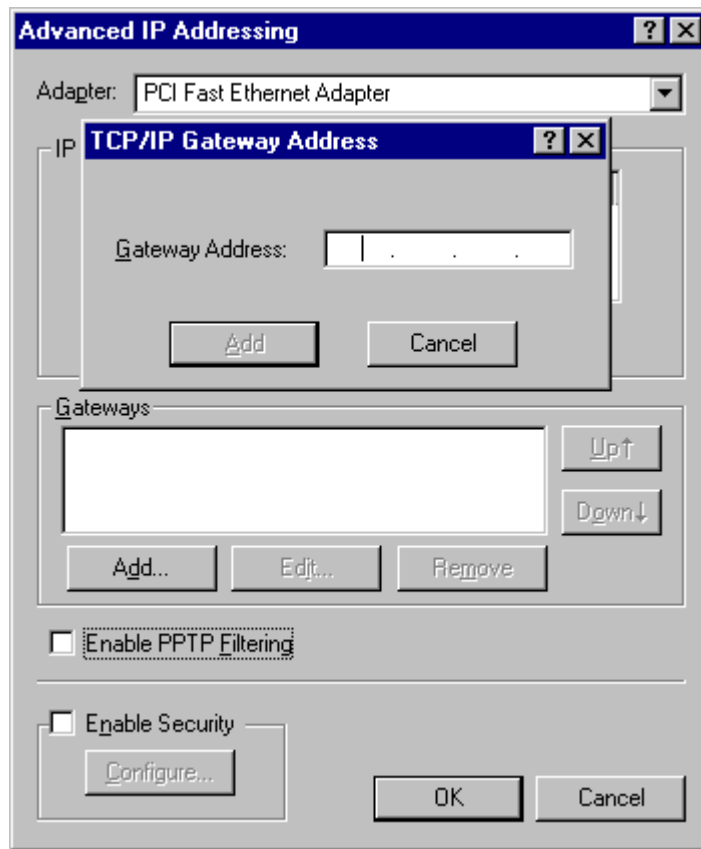

**Figure 15 - Windows NT4.0 - Add Gateway**

2. The DNS should be set to the address provided by your ISP, as follows:
  - Click the DNS tab.
  - On the DNS screen, shown below, click the *Add* button (under *DNS Service Search Order*), and enter the DNS provided by your ISP.

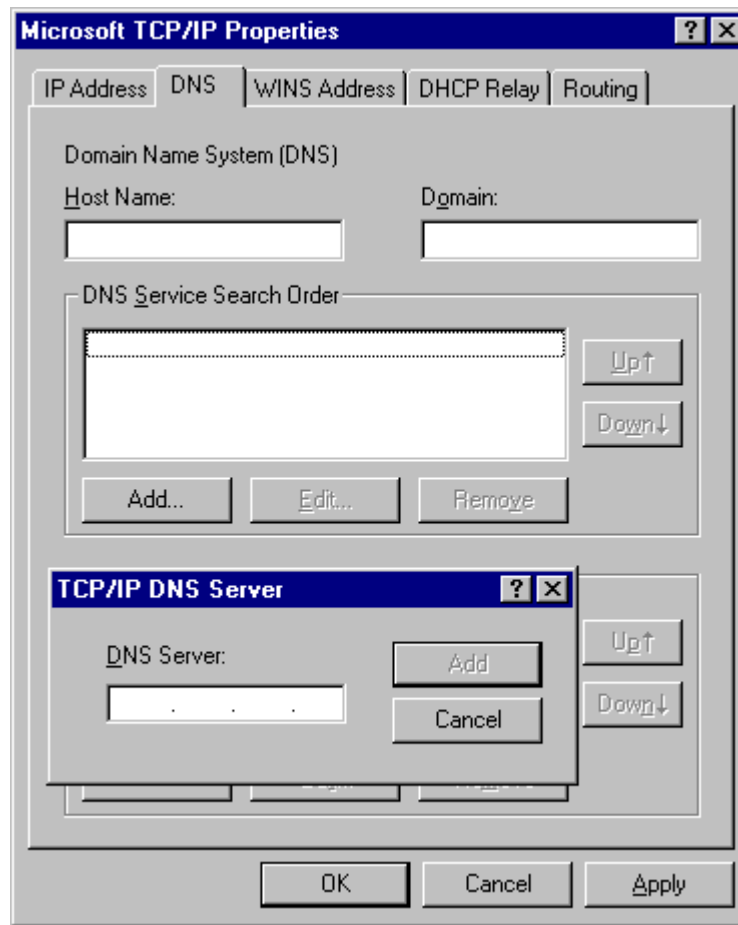
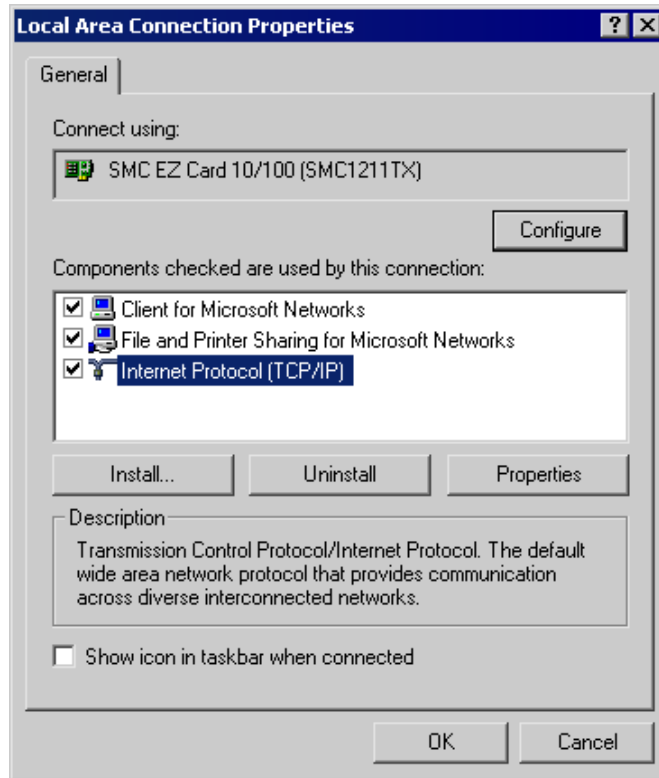

Figure 16: Windows NT4.0 - DNS

## Checking TCP/IP Settings - Windows 2000:

1. Select *Control Panel - Network and Dial-up Connection*.
2. Right - click the *Local Area Connection* icon and select *Properties*. You should see a screen like the following:



**Figure 17: Network Configuration (Win 2000)**

3. Select the *TCP/IP* protocol for your network card.
4. Click on the *Properties* button. You should then see a screen like the following.

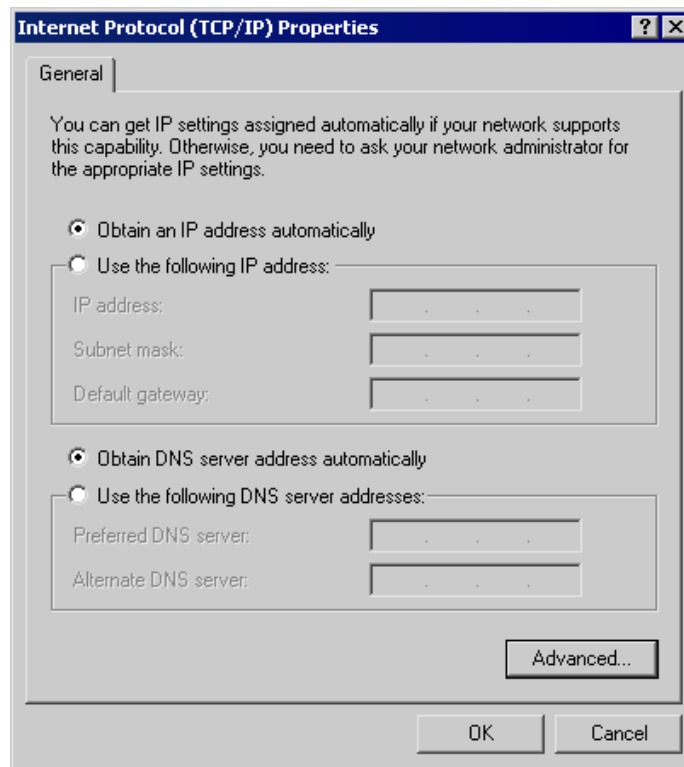

**Figure 18: TCP/IP Properties (Win 2000)**

5. Ensure your TCP/IP settings are correct, as described below.

### Using DHCP

To use DHCP, select the radio button *Obtain an IP Address automatically*. This is the default Windows setting. **Using this is recommended.** By default, the Broadband Router will act as a DHCP Server.

Restart your PC to ensure it obtains an IP Address from the Broadband Router.

### Using a fixed IP Address ("Use the following IP Address")

If your PC is already configured, check with your network administrator before making the following changes.

- Enter the Broadband Router's IP address in the *Default gateway* field and click *OK*. (Your LAN administrator can advise you of the IP Address they assigned to the Broadband Router.)
- If the *DNS Server* fields are empty, select *Use the following DNS server addresses*, and enter the DNS address or addresses provided by your ISP, then click *OK*.

## Checking TCP/IP Settings - Windows XP

1. Select *Control Panel - Network Connection*.
2. Right click the *Local Area Connection* and choose *Properties*. You should see a screen like the following:

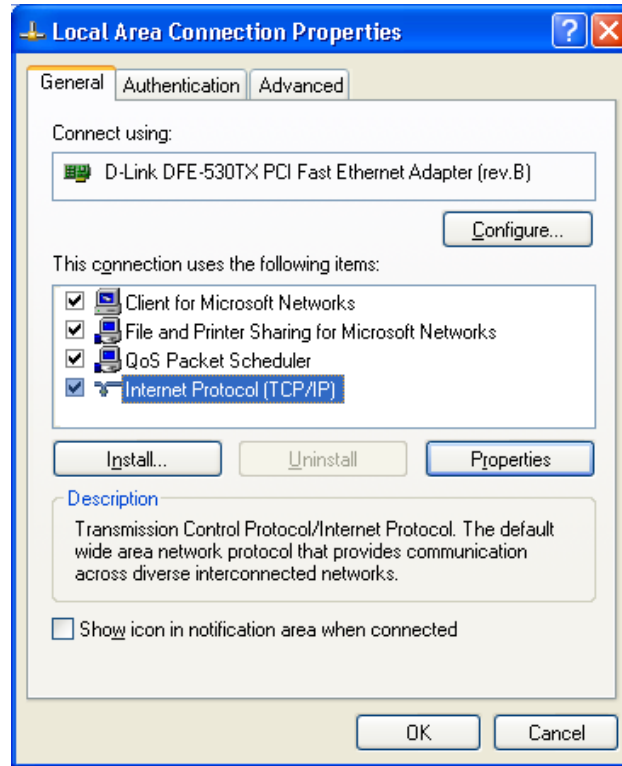

**Figure 19: Network Configuration (Windows XP)**

3. Select the *TCP/IP* protocol for your network card.
4. Click on the *Properties* button. You should then see a screen like the following.



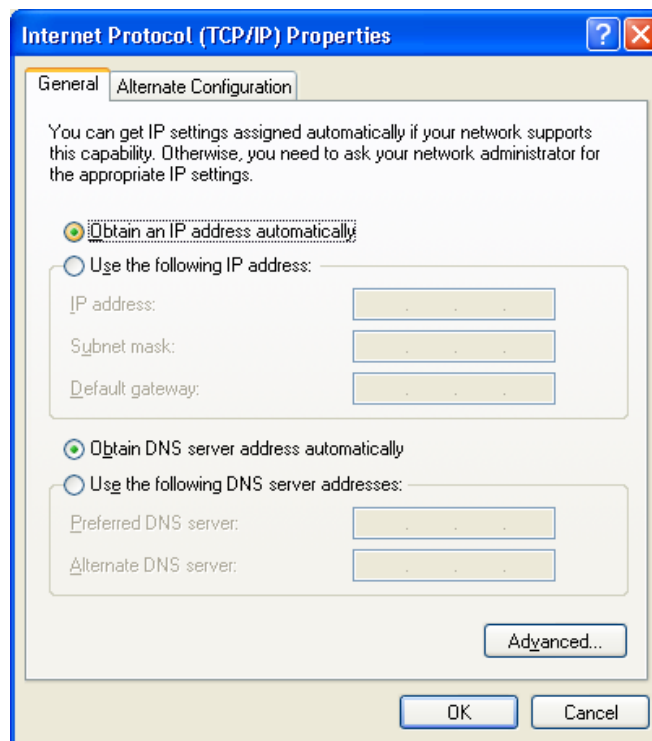

**Figure 20: TCP/IP Properties (Windows XP)**

5. Ensure your TCP/IP settings are correct.

### Using DHCP

To use DHCP, select the radio button *Obtain an IP Address automatically*. This is the default Windows setting. **Using this is recommended.** By default, the Broadband Router will act as a DHCP Server.

Restart your PC to ensure it obtains an IP Address from the Broadband Router.

### Using a fixed IP Address ("Use the following IP Address")

If your PC is already configured, check with your network administrator before making the following changes.

- In the *Default gateway* field, enter the Broadband Router's IP address and click *OK*. Your LAN administrator can advise you of the IP Address they assigned to the Broadband Router.
- If the *DNS Server* fields are empty, select *Use the following DNS server addresses*, and enter the DNS address or addresses provided by your ISP, then click *OK*.

## Checking TCP/IP Settings - Windows Vista

1. From the Start menu, right-click Network, then click Properties. Now, the Network and Sharing Center displays.

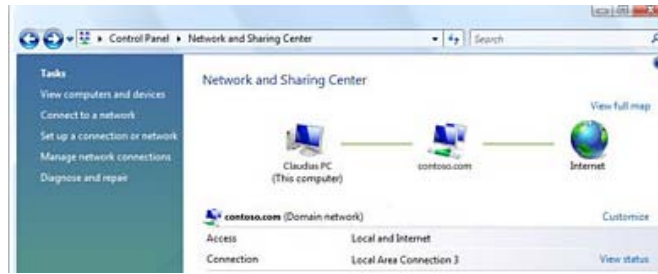

2. Under Tasks located on the left-hand side of the window, click Manage network connections.



3. In Network Connections window displays, right click on the correct Local Area Connection, then click Properties.

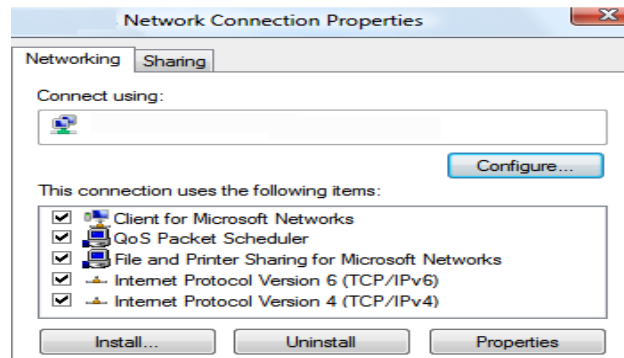

4. Pop-up window displays that states Windows needs your permission to continue. Click Continue to open the Local Area Connection Properties window

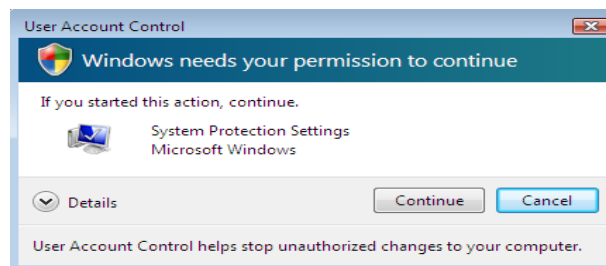

5. Select Internet Protocol Version 4 (TCP/IPv4), then click Properties. From the General tab, verify that Obtain an IP address automatically and Obtain DNS server address automatically are selected. Click the OK button.

The image shows a standard Windows dialog box for configuring DNS. It features two radio buttons at the top. The first radio button, labeled "Obtain DNS server address automatically", is selected with a blue dot. The second radio button, labeled "Use the following DNS server addresses:", is unselected. Below the second radio button is a sub-dialog box containing two text input fields. The first field is labeled "Preferred DNS server:" and the second is labeled "Alternate DNS server:". Both fields contain three dots, indicating they are empty. To the right of this sub-dialog box is a button labeled "Advanced...". At the bottom of the main dialog box are two buttons: "OK" on the left and "Cancel" on the right.

## Internet Access

To configure your PCs to use the Broadband Router for Internet access:

- Ensure that the DSL modem, Cable modem, or other permanent connection is functional.
- Use the following procedure to configure your Browser to access the Internet via the LAN, rather than by a Dial-up connection.

### For Windows 9x/ME/2000

1. Select *Start Menu - Settings - Control Panel - Internet Options*.
2. Select the *Connection* tab, and click the *Setup* button.
3. Select "I want to set up my Internet connection manually, or I want to connect through a local area network (LAN)" and click *Next*.
4. Select "I connect through a local area network (LAN)" and click *Next*.
5. Ensure all of the boxes on the following Local area network Internet Configuration screen are **unchecked**.
6. Check the "No" option when prompted "Do you want to set up an Internet mail account now?".
7. Click *Finish* to close the Internet Connection Wizard.  
Setup is now completed.

### For Windows XP

1. Select *Start Menu - Control Panel - Network and Internet Connections*.
2. Select *Set up or change your Internet Connection*.
3. Select the *Connection* tab, and click the *Setup* button.
4. Cancel the pop-up "Location Information" screen.
5. Click *Next* on the "New Connection Wizard" screen.
6. Select "Connect to the Internet" and click *Next*.
7. Select "Set up my connection manually" and click *Next*.
8. Check "Connect using a broadband connection that is always on" and click *Next*.
9. Click *Finish* to close the New Connection Wizard.  
Setup is now completed.

### For Windows Vista

1. Select *Start Menu - Control Panel - Network and Internet Connections*
2. Select the *Network and Sharing Center* icon.
3. Select *Set up a Connection or Network*
4. A new window will pop up, choose the *Connection* option.
5. Select *Connect to the Internet*
6. Select the *Connection* from the list and click on next.

### Accessing AOL

To access AOL (America On Line) through the Broadband Router, the *AOL for Windows* software must be configured to use TCP/IP network access, rather than a dial-up connection. The configuration process is as follows:

- Start the *AOL for Windows* communication software. Ensure that it is Version 2.5, 3.0 or later. This procedure will not work with earlier versions.
- Click the *Setup* button.
- Select *Create Location*, and change the location name from "New Locality" to "Broadband Router".
- Click *Edit Location*. Select *TCP/IP* for the *Network* field. (Leave the *Phone Number* blank.)
- Click *Save*, then *OK*.  
Configuration is now complete.

- Before clicking "Sign On", always ensure that you are using the "Broadband Router" location.

## Macintosh Clients

# 5

From your Macintosh, you can access the Internet via the Broadband Router. The procedure is as follows.

1. Open the TCP/IP Control Panel.
2. Select *Ethernet* from the *Connect via* pop-up menu.
3. Select *Using DHCP Server* from the *Configure* pop-up menu. The DHCP Client ID field can be left blank.
4. Close the TCP/IP panel, saving your settings.

### Note:

If using manually assigned IP addresses instead of DHCP, the required changes are:

- Set the *Router Address* field to the Broadband Router's IP Address.
- Ensure your DNS settings are correct.

## Linux Clients

To access the Internet via the Broadband Router, it is only necessary to set the Broadband Router as the "Gateway".

**Ensure you are logged in as "root" before attempting any changes.**

### Fixed IP Address

By default, most Unix installations use a fixed IP Address. If you wish to continue using a fixed IP Address, make the following changes to your configuration.

- Set your "Default Gateway" to the IP Address of the Broadband Router.
- Ensure your DNS (Name server) settings are correct.

### To act as a DHCP Client (recommended)

The procedure below may vary according to your version of Linux and X -windows shell.

1. Start your X Windows client.
2. Select *Control Panel - Network*
3. Select the "Interface" entry for your Network card. Normally, this will be called "eth0".
4. Click the *Edit* button, set the "protocol" to "DHCP", and save this data.
5. To apply your changes
  - Use the "Deactivate" and "Activate" buttons, if available.
  - OR, restart your system.

## Other Unix Systems

To access the Internet via the Broadband Router:

- Ensure the "Gateway" field for your network card is set to the IP Address of the Broadband Router.
- Ensure your DNS (Name Server) settings are correct.

# Chapter 5

## Operation and Status

*This Chapter details the operation of the Broadband Router and the status screens.*

### Operation

Once both the Broadband Router and the PCs are configured, operation is automatic.

However, there are some situations where additional Internet configuration may be required:

- If using Internet-based **Communication Applications**, it may be necessary to specify which PC receives an incoming connection. Refer to *Chapter 6 - Advanced Features* for further details.
- Applications which use non-standard connections or port numbers may be blocked by the Broadband Router's built-in firewall. You can define such applications as **Special Applications** to allow them to function normally. Refer to *Chapter 6 - Advanced Features* for further details.
- Some non-standard applications may require use of the **DMZ** feature. Refer to *Chapter 6 - Advanced Features* for further details.

### Status Screen

Use the **Status** link on the main menu to view this screen.

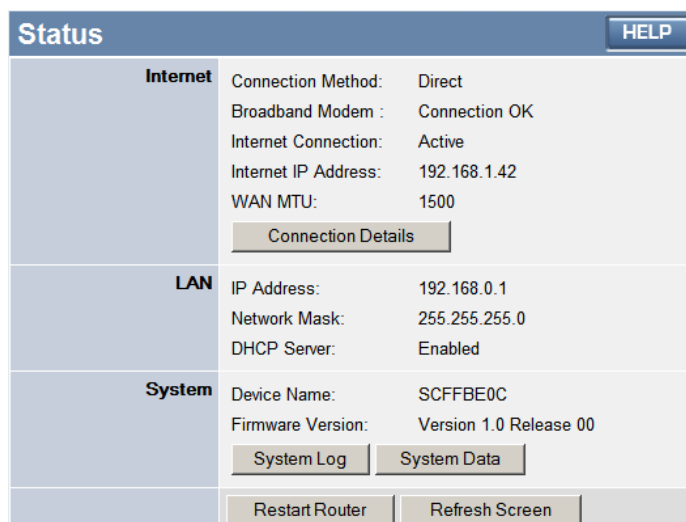

**Figure 21: Status Screen**

#### Data - Status Screen

Internet	
<b>Connection Method</b>	This indicates the current connection method, as set in the Setup Wizard.
<b>Broadband Modem</b>	This shows the connection status of the modem.
<b>Internet Connection</b>	Current connection status: <ul style="list-style-type: none"> <li>• Active</li> </ul>

	<ul style="list-style-type: none"> <li>• Idle</li> <li>• Unknown</li> <li>• Failed</li> </ul> <p>If there is an error, you can click the "Connection Details" button to find out more information.</p>
<b>Internet IP Address</b>	This IP Address is allocated by the ISP (Internet Service Provider).
<b>WAN MTU</b>	Displays the current value of MTU.
<b>"Connection Details" Button</b>	Click this button to open a sub-window and view a detailed description of the current connection. Depending on the type of connection, a "log" may also be available.
<b>LAN</b>	
<b>IP Address</b>	The IP Address of the Broadband Router.
<b>Network Mask</b>	The Network Mask (Subnet Mask) for the IP Address above.
<b>DHCP Server</b>	<p>This shows the status of the DHCP Server function - either "Enabled" or "Disabled".</p> <p>For additional information about the PCs on your LAN, and the IP addresses allocated to them, use the <i>PC Database</i> option on the <i>Advanced</i> menu.</p>
<b>System</b>	
<b>Device Name</b>	This displays the current name of the Broadband Router.
<b>Firmware Version</b>	The current version of the firmware installed in the Broadband Router.
<b>Buttons</b>	
<b>Connection Details</b>	View the details of the current Internet connection. The sub-screen displayed will depend on the connection method used. See the following sections for details of each sub-screen.
<b>System Data</b>	Display all system information in a sub-window.
<b>Restart</b>	Clicking this button will restart (reboot) the Broadband Router. All existing connections though the Broadband Router will be terminated, but will usually re-connect automatically.
<b>Refresh Screen</b>	Update the data displayed on screen.

## Connection Details - Fixed/Dynamic IP Address

If your access method is "Direct" (no login), a screen like the following example will be displayed when the "Connection Details" button is clicked.



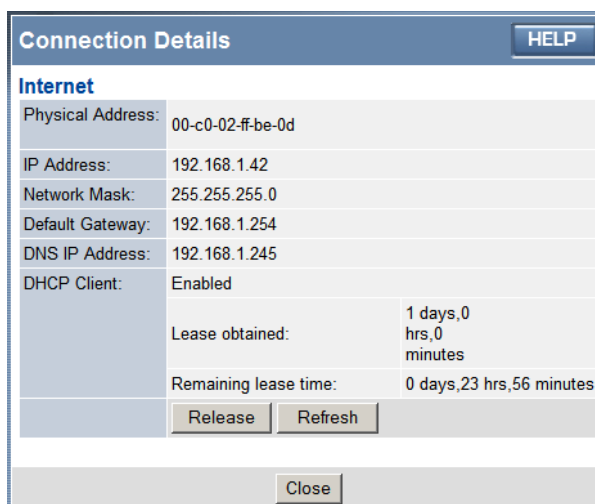

Figure 22: Connection Details - Fixed/Dynamic IP Address

**Data - Fixed/Dynamic IP address Screen**

Internet	
<b>Physical Address</b>	The hardware address of this device, as seen by remote devices on the Internet. (This is different to the hardware address seen by devices on the local LAN.)
<b>IP Address</b>	The IP Address of this device, as seen by Internet users. This address is allocated by your ISP (Internet Service Provider).
<b>Network Mask</b>	The Network Mask associated with the IP Address above.
<b>Default Gateway</b>	The IP Address of the remote Gateway or Router associated with the IP Address above.
<b>DNS IP Address</b>	The IP Address of the Domain Name Server which is currently used.
<b>DHCP Client</b>	<p>This will show "Enabled" or "Disabled", depending on whether or not this device is functioning as a DHCP client.</p> <p>If "Enabled" the "Remaining lease time" field indicates when the IP Address allocated by the DHCP Server will expire. The lease is automatically renewed on expiry; use the "Renew" button if you wish to manually renew the lease immediately.</p>
Buttons	
<b>Release/Renew</b> <b>Button will display EITHER "Release" OR "Renew"</b>	<p>This button is only useful if the IP address shown above is allocated automatically on connection. (Dynamic IP address). If you have a Fixed (Static) IP address, this button has no effect.</p> <ul style="list-style-type: none"> <li>• If the ISP's DHCP Server has NOT allocated an IP Address for the Broadband Router, this button will say "Renew". Clicking the "Renew" button will attempt to re-establish the connection and obtain an IP Address from the ISP's DHCP Server.</li> <li>• If an IP Address has been allocated to the Broadband Router (by the ISP's DHCP Server), this button will say "Release". Clicking the "Release" button will break the connection and release the IP Address.</li> </ul>
<b>Refresh</b>	Update the data shown on screen.

## Connection Status - PPPoE

If using PPPoE (PPP over Ethernet), a screen like the following example will be displayed when the "Connection Details" button is clicked.

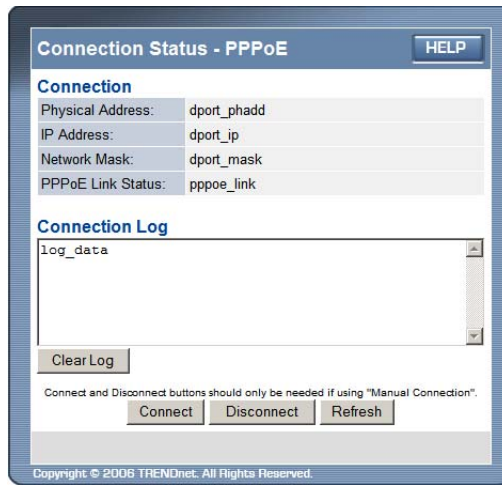

**Figure 23: PPPoE Status Screen**

### Data - PPPoE Screen

Connection	
<b>Physical Address</b>	The hardware address of this device, as seen by remote devices on the Internet. (This is different to the hardware address seen by devices on the local LAN.)
<b>IP Address</b>	The IP Address of this device, as seen by Internet users. This address is allocated by your ISP (Internet Service Provider).
<b>Network Mask</b>	The Network Mask associated with the IP Address above.
<b>PPPoE Link Status</b>	<p>This indicates whether or not the connection is currently established.</p> <ul style="list-style-type: none"> <li>• If the connection does not exist, the "Connect" button can be used to establish a connection.</li> <li>• If the connection currently exists, the "Disconnect" button can be used to break the connection.</li> </ul>
Connection Log	
<b>Connection Log</b>	<ul style="list-style-type: none"> <li>• The Connection Log shows status messages relating to the existing connection.</li> <li>• The most common messages are listed in the table below.</li> <li>• The "Clear Log" button will restart the Log, while the Refresh button will update the messages shown on screen.</li> </ul>
Buttons	
<b>Connect</b>	If not connected, establish a connection to your ISP.
<b>Disconnect</b>	If connected to your ISP, hang up the connection.
<b>Clear Log</b>	Delete all data currently in the Log. This will make it easier to read new messages.
<b>Refresh</b>	Update the data on screen.

## Connection Log Messages

Message	Description
Connect on Demand	Connection attempt has been triggered by the "Connect automatically, as required" setting.
Manual connection	Connection attempt started by the "Connect" button.
Reset physical connection	Preparing line for connection attempt.
Connecting to remote server	Attempting to connect to the ISP's server.
Remote Server located	ISP's Server has responded to connection attempt.
Start PPP	Attempting to login to ISP's Server and establish a PPP connection.
PPP up successfully	Able to login to ISP's Server and establish a PPP connection.
Idle time-out reached	The connection has been idle for the time period specified in the "Idle Time-out" field. The connection will now be terminated.
Disconnecting	The current connection is being terminated, due to either the "Idle Time-out" above, or "Disconnect" button being clicked.
Error: Remote Server not found	ISP's Server did not respond. This could be a Server problem, or a problem with the link to the Server.
Error: PPP Connection failed	Unable to establish a PPP connection with the ISP's Server. This could be a login problem (name or password) or a Server problem.
Error: Connection to Server lost	The existing connection has been lost. This could be caused by a power failure, a link failure, or Server failure.
Error: Invalid or unknown packet type	The data received from the ISP's Server could not be processed. This could be caused by data corruption (from a bad link), or the Server using a protocol which is not supported by this device.

## Connection Status - PPTP

If using PPTP (Peer-to-Peer Tunneling Protocol), a screen like the following example will be displayed when the "Connection Details" button is clicked.

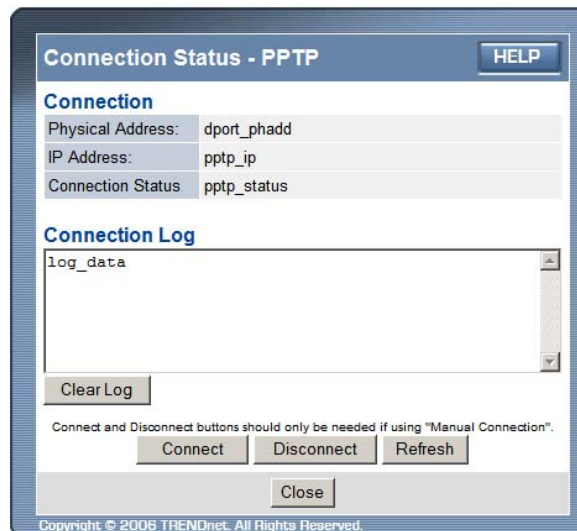

Figure 24: PPTP Status Screen

### Data - PPTP Screen

Connection	
<b>Physical Address</b>	The hardware address of this device, as seen by remote devices on the Internet. (This is different to the hardware address seen by devices on the local LAN.)
<b>IP Address</b>	The IP Address of this device, as seen by Internet users. This address is allocated by your ISP (Internet Service Provider).
<b>PPTP Status</b>	This indicates whether or not the connection is currently established. <ul style="list-style-type: none"> <li>• If the connection does not exist, the "Connect" button can be used to establish a connection.</li> <li>• If the connection currently exists, the "Disconnect" button can be used to break the connection.</li> </ul>
Connection Log	
<b>Connection Log</b>	<ul style="list-style-type: none"> <li>• The Connection Log shows status messages relating to the existing connection.</li> <li>• The "Clear Log" button will restart the Log, while the Refresh button will update the messages shown on screen.</li> </ul>
Buttons	
<b>Connect</b>	If not connected, establish a connection to your ISP.
<b>Disconnect</b>	If connected to your ISP, hang up the connection.
<b>Clear Log</b>	Delete all data currently in the Log. This will make it easier to read new messages.
<b>Refresh</b>	Update the data on screen.

## Connection Status - L2TP

If using L2TP, a screen like the following example will be displayed when the "Connection Details" button is clicked.

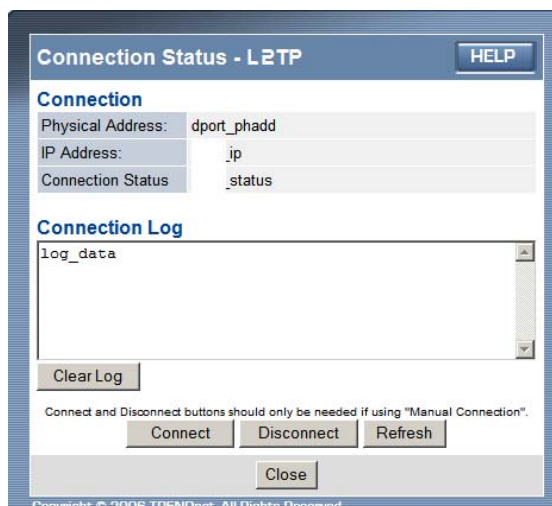

**Figure 25: L2TP Status Screen**

### Data - L2TP Screen

Connection	
<b>Physical Address</b>	The hardware address of this device, as seen by remote devices on the Internet. (This is different to the hardware address seen by devices on the local LAN.)
<b>IP Address</b>	The IP Address of this device, as seen by Internet users. This address is allocated by your ISP (Internet Service Provider).
<b>Connection Status</b>	This indicates whether or not the connection is currently established. <ul style="list-style-type: none"> <li>If the connection does not exist, the "Connect" button can be used to establish a connection.</li> <li>If the connection currently exists, the "Disconnect" button can be used to break the connection.</li> </ul>
Connection Log	
<b>Connection Log</b>	<ul style="list-style-type: none"> <li>The Connection Log shows status messages relating to the existing connection.</li> <li>The "Clear Log" button will restart the Log, while the Refresh button will update the messages shown on screen.</li> </ul>
Buttons	
<b>Connect</b>	If not connected, establish a connection to your ISP.
<b>Disconnect</b>	If connected to your ISP, hang up the connection.
<b>Clear Log</b>	Delete all data currently in the Log. This will make it easier to read new messages.
<b>Refresh</b>	Update the data on screen.

## Connection Status - Telstra Big Pond

An example screen is shown below.

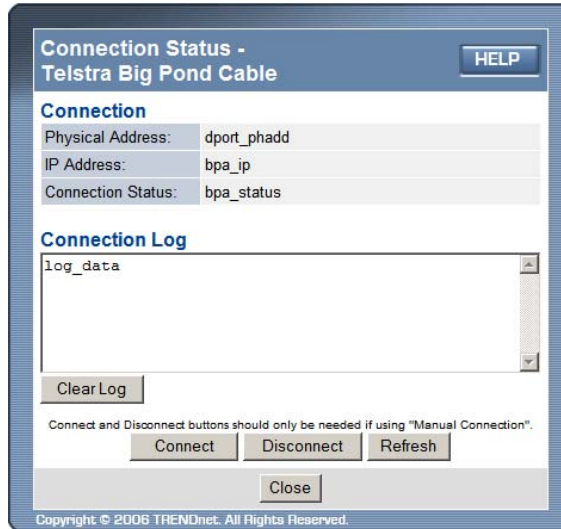

**Figure 26: Telstra Big Pond Status Screen**

### Data - Big Pond Screen

Connection	
<b>Physical Address</b>	The hardware address of this device, as seen by remote devices. (This is different to the hardware address seen by devices on the local LAN.)
<b>IP Address</b>	The IP Address of this device, as seen by Internet users. This address is allocated by your ISP (Internet Service Provider).
<b>Connection Status</b>	<p>This indicates whether or not the connection is currently established.</p> <ul style="list-style-type: none"> <li>• If the connection does not exist, the "Connect" button can be used to establish a connection.</li> <li>• If the connection currently exists, the "Disconnect" button can be used to break the connection.</li> <li>• Normally, it is not necessary to use the Connect and Disconnect buttons unless the setting "Connect automatically, as required" is disabled.</li> </ul>
Connection Log	
<b>Connection Log</b>	<ul style="list-style-type: none"> <li>• The Connection Log shows status messages relating to the existing connection.</li> <li>• The Clear Log button will restart the Log, while the Refresh button will update the messages shown on screen.</li> </ul>
Buttons	
<b>Connect</b>	If not connected, establish a connection to Telstra Big Pond.
<b>Disconnect</b>	If connected to Telstra Big Pond, terminate the connection.
<b>Clear Log</b>	Delete all data currently in the Log. This will make it easier to read new messages.

<b>Refresh</b>	Update the data on screen.
----------------	----------------------------

## Connection Details - SingTel RAS

If using the SingTel RAS access method, a screen like the following example will be displayed when the "Connection Details" button is clicked.

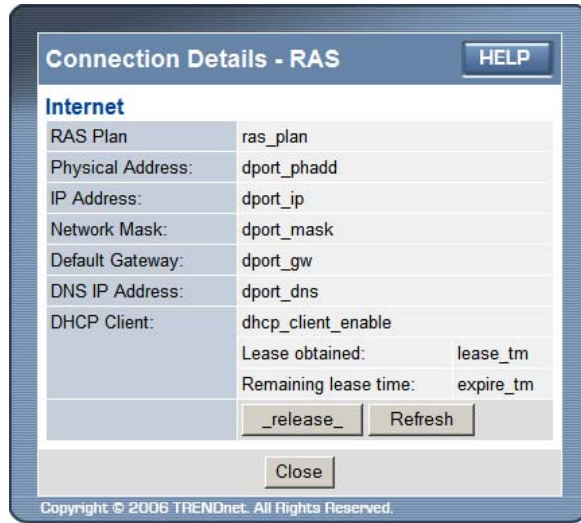

**Figure 27: Connection Details - RAS**

### Data - RAS Screen

Internet	
<b>RAS Plan</b>	The RAS Plan which is currently used.
<b>Physical Address</b>	The hardware address of this device, as seen by remote devices on the Internet. (This is different to the hardware address seen by devices on the local LAN.)
<b>IP Address</b>	The IP Address of this device, as seen by Internet users. This address is allocated by your ISP (Internet Service Provider).
<b>Network Mask</b>	The Network Mask associated with the IP Address above.
<b>Default Gateway</b>	The IP Address of the remote Gateway or Router associated with the IP Address above.
<b>DNS IP Address</b>	The IP Address of the Domain Name Server which is currently used.
<b>DHCP Client</b>	<p>This will show "Enabled" or "Disabled", depending on whether or not this device is functioning as a DHCP client.</p> <p>If "Enabled" the "Remaining lease time" field indicates when the IP Address allocated by the DHCP Server will expire. The lease is automatically renewed on expiry; use the "Renew" button if you wish to manually renew the lease immediately.</p>
Buttons	
<p><b>Release/Renew</b></p> <p><b>Button will display EITHER "Release" OR "Renew"</b></p>	<p>This button is only useful if the IP address shown above is allocated automatically on connection. (Dynamic IP address). If you have a Fixed (Static) IP address, this button has no effect.</p> <ul style="list-style-type: none"> <li>If the ISP's DHCP Server has NOT allocated an IP Address for the Broadband Router, this button will say "Renew". Clicking the "Renew" button will attempt to re-establish the connection and obtain an IP Address from the ISP's DHCP Server.</li> </ul>



## 6

	<ul style="list-style-type: none"> <li>If an IP Address has been allocated to the Broadband Router (by the ISP's DHCP Server), this button will say "Release". Clicking the "Release" button will break the connection and release the IP Address.</li> </ul>
<b>Refresh</b>	Update the data shown on screen.

## Chapter 6

# Advanced Features

*This Chapter explains when and how to use the Broadband Router's "Advanced" Features.*

## Overview

The following advanced features are provided.

- Access Control
- Dynamic DNS
- Advanced Internet
  - Communication Applications
  - Special Applications
  - DMZ
  - Multi-DMZ
- URL Filter
- Schedule
- User Groups
- Virtual Servers
- WAN Port

## Access Control

This feature is accessed by the *Access Control* link on the Advanced menu.

### Overview

The Access Control feature allows administrators to restrict the level of Internet Access available to PCs on your LAN. With the default settings, everyone has unrestricted Internet access.

#### To use this feature:

1. Set the desired restrictions on the "Default" group. All PCs are in the "Default" group unless explicitly moved to another group.
2. Set the desired restrictions on the other groups ("Group 1", "Group 2", "Group 3" and "Group 4") as needed.
3. Assign PC to the groups as required.



**Note**

Restrictions are imposed by blocking "Services", or types of connections. All common Services are pre-defined. If required, you can also define your own Services.

## Access Control Screen

To view this screen, select the *Access Control* link on the Advanced menu.

Figure 28: Access Control Screen

### Data - Access Control Screen

Group	
<b>Group</b>	Select the desired Group. The screen will update to display the settings for the selected Group. Groups are named "Default", "Group 1", "Group 2", "Group 3" and "Group 4", and cannot be re-named.
Internet Access	
<b>Restrictions</b>	Select the desired options for the current group: <ul style="list-style-type: none"> <li>• <b>None</b> - Nothing is blocked. Use this to create the least restrictive group.</li> <li>• <b>Block all Internet access</b> - All traffic via the WAN port is blocked. Use this to create the most restrictive group.</li> <li>• <b>Block selected Services</b> - You can select which Services are to block. Use this to gain fine control over the Internet access for a group.</li> </ul>
<b>Block by Schedule</b>	If Internet access is being blocked, you can choose to apply the blocking only during scheduled times. (If access is not blocked, no Scheduling is possible, and this setting has no effect.) You can define or modify the Schedule using the <b>Schedule</b> option on the <b>Advanced</b> menu.
<b>Services</b>	This lists all defined Services. Select the Services you wish to block. To select multiple services, hold the CTRL key while selecting. (On the Macintosh, hold the SHIFT key rather than CTRL.)
<b>Edit Service List Button</b>	If you wish to define additional Services, or manage the Service list, click this button to open the "Services" screen.

<b>Buttons</b>	
<b>Edit Service List</b>	If you wish to define additional Services, or manage the Service list, click this button to open the "Services" screen.
<b>Save</b>	Save the data on screen.
<b>Cancel</b>	Reverse any changes made since the last "Save".
<b>View Log</b>	Click this to open a sub-window where you can view the "Access Control" log. This log shows attempted Internet accesses which have been blocked by the Access Control feature.
<b>Clear Log</b>	Click this to clear and restart the "Access Control" log, making new entries easier to read.
<b>Refresh</b>	Update the data on screen.

## Services Screen

This screen is displayed when the *Edit Service List* button on the *Access Control* screen is clicked.

The screenshot shows a window titled "Services" with a "HELP" button in the top right corner. Below the title bar, there are two main sections:

- Available Services:** A list box containing the following items: ALL( TCP/UDP:1..65534 ), AIM( TCP:5190 ), BGP( TCP:179 ), BOOTP\_CLIENT( UDP:68 ), BOOTP\_SERVER( UDP:67,68 ), and CU-SEEME( TCP/UDP:7648 ). Below the list is a "Delete" button.
- Add New Service:** A form with the following fields:
  - Name:
  - Type:  (dropdown menu)
  - Port (TCP or UDP): Start:  Finish:
  - ICMP Type:  (0..255)
 Below the form are "Add", "Cancel", and "Close" buttons.

Figure 29: Access Control - Services

## Data - Services Screen

Available Services	
<b>Available Services</b>	This lists all the available services.
<b>"Delete" button</b>	Use this to delete any Service you have added. Pre-defined Services can not be deleted.
Add New Service	
<b>Name</b>	Enter a descriptive name to identify this service.
<b>Type</b>	Select the protocol (TCP, UDP, ICMP) used to the remote system or service.
<b>Start Port</b>	For TCP and UDP Services, enter the beginning of the range of port numbers used by the service. If the service uses a single port number, enter it in both the "Start" and "Finish" fields.
<b>Finish Port</b>	For TCP and UDP Services, enter the end of the range of port numbers used by the service. If the service uses a single port number, enter it in both the "Start" and "Finish" fields.
<b>ICMP Type</b>	For ICMP Services, enter the type number of the required service.
Buttons	
<b>Delete</b>	Delete the selected service from the list.
<b>Save</b>	Add a new entry to the Service list, using the data shown in the "Add New Service" area on screen.
<b>Cancel</b>	Clear the " Add New Service " area, ready for entering data for a new Service.

## Access Control Log

To check the operation of the Access Control feature, an *Access Control Log* is provided. Click the *View Log* button on the *Access Control* screen to view this log.

This log shows attempted Internet accesses which have been **blocked** by the *Access Control* function.

Data shown in this log is as follows:

<b>Date/Time</b>	Date and Time of the attempted access.
<b>Name</b>	If known, the name of the PC whose access was blocked.
<b>Source IP address</b>	The IP Address of the PC or device whose access request was blocked
<b>MAC address</b>	The hardware or physical address of the PC or device whose access request was blocked
<b>Destination</b>	The destination URL or IP address

## Dynamic DNS (Domain Name Server)

This free service is very useful when combined with the *Virtual Server* feature. It allows Internet users to connect to your Virtual Servers using a URL, rather than an IP Address.

This also solves the problem of having a dynamic IP address. With a dynamic IP address, your IP address may change whenever you connect, which makes it difficult to connect to you.

### The Service works as follows:

1. You must register for the service at one of the listed DDNS Service Providers.
2. After registration, follow the service provider's procedure to request a Domain Name and have it allocated to you.
3. Enter your DDNS data on the Broadband Router's DDNS screen.
4. The Broadband Router will then automatically ensure that your current IP Address is recorded at the DDNS server. If the DDNS Service provides software to perform this "IP address update"; you should disable the "Update" function, or not use the software at all.
5. From the Internet, users will be able to connect to your Virtual Servers (or DMZ PC) using your Domain Name.

## Dynamic DNS Screen

Select *Advanced* on the main menu, then *Dynamic DNS*, to see a screen like the following:

Figure 30: DDNS Screen

### Data - Dynamic DNS Screen

DDNS Service	
<b>DDNS Service</b>	Select the desired DDNS Service provider.
<b>Web Site Button</b>	Click this button to open a new window and connect to the Web site for the selected DDNS service provider.
<b>DDNS Status</b>	<ul style="list-style-type: none"> <li>• This message is returned by the DDNS Server.</li> <li>• Normally, this message should be something like "Update successful" (current IP address was updated on the DDNS server).</li> <li>• If the message is "No host", this indicates the host name entered was not allocated to you. If you see this, or some other error message, you need to contact the DDNS Service and correct the problem.</li> </ul>

<b>DDNS Data</b>	
<b>User Name</b>	Enter your Username for the DDNS Service.
<b>Password/Key</b>	Enter your current password for the DDNS Service.
<b>Domain Name</b>	Enter the domain name allocated to you by the DDNS Service. If you have more than one name, enter the name you wish to use.



## Advanced Internet Screen

This screen allows configuration of all advanced features relating to Internet access.

- Communication Applications
- Special Applications
- DMZ
- Multi-DMZ

An example screen is shown below.

**Figure 31: Internet Screen**

## Communication Applications

Most applications are supported transparently by the Broadband Router. But sometimes it is not clear which PC should receive an incoming connection. This problem could arise with the *Communication Applications* listed on this screen.

If this problem arises, you can use this screen to set which PC should receive an incoming connection, as described below.

Communication Applications	
<b>Select an Application</b>	This lists applications which may generate incoming connections, where the destination PC (on your local LAN) is unknown.
<b>Send incoming calls to</b>	<p>This lists the PCs on your LAN.</p> <ul style="list-style-type: none"> <li>• If necessary, you can add PCs manually, using the "PC Database" option on the advanced menu.</li> <li>• For each application listed above, you can choose a destination PC.</li> <li>• There is no need to "Save" after each change; you can set the destination PC for each application, then click "Save".</li> </ul>

## Special Applications

If you use Internet applications which use non-standard connections or port numbers, you may find that they do not function correctly because they are blocked by the Broadband Router's firewall. In this case, you can define the application as a "Special Application".

## Special Applications Screen

This screen can be reached by clicking the *Special Applications* button on the *Internet* screen.

You can then define your Special Applications. You will need detailed information about the application; this is normally available from the supplier of the application.

Also, note that the terms "Incoming" and "Outgoing" on this screen refer to traffic from the client (PC) viewpoint

**Special Applications**
HELP

Special Applications can only be used by 1 user at any time.

Name	Incoming Ports			Outgoing Ports		
	Type	Start	Finish	Type	Start	Finish
1. <input type="checkbox"/> dialpad	udp	51200	51201	udp	51200	51201
2. <input type="checkbox"/> paltalk	udp	2090	2091	udp	2090	2091
3. <input type="checkbox"/> quicktime	udp	6970	6999	tcp	554	554
4. <input type="checkbox"/>	udp			udp		
5. <input type="checkbox"/>	udp			udp		
6. <input type="checkbox"/>	udp			udp		
7. <input type="checkbox"/>	udp			udp		
8. <input type="checkbox"/>	udp			udp		
9. <input type="checkbox"/>	udp			udp		
10. <input type="checkbox"/>	udp			udp		
11. <input type="checkbox"/>	udp			udp		
12. <input type="checkbox"/>	udp			udp		

**Figure 32: Special Applications Screen**

## Data - Special Applications Screen

<b>Checkbox</b>	Use this to Enable or Disable this Special Application as required.
<b>Name</b>	Enter a descriptive name to identify this Special Application.
<b>Incoming Ports</b>	<ul style="list-style-type: none"> <li>• <b>Type</b> - Select the protocol (TCP or UDP) used when you receive data from the special application or service. (Note: Some applications use different protocols for outgoing and incoming data).</li> <li>• <b>Start</b> - Enter the beginning of the range of port numbers used by the application server, for data you receive. If the application uses a single port number, enter it in both the "Start" and "Finish" fields.</li> <li>• <b>Finish</b> - Enter the end of the range of port numbers used by the application server, for data you receive.</li> </ul>
<b>Outgoing Ports</b>	<ul style="list-style-type: none"> <li>• <b>Type</b> - Select the protocol (TCP or UDP) used when you send data to the remote system or service.</li> <li>• <b>Start</b> - Enter the beginning of the range of port numbers used by the application server, for data you send to it. If the application uses a single port number, enter it in both the "Start" and "Finish" fields.</li> <li>• <b>Finish</b> - Enter the end of the range of port numbers used by the application server, for data you send to it. If the application uses a single port number, enter it in both the "Start" and "Finish" fields.</li> </ul>

## Using a Special Application

- Configure the *Special Applications* screen as required.
- On your PC, use the application normally. Remember that only one (1) PC can use each Special application at any time. Also, when 1 PC is finished using a particular Special Application, there may need to be a "Time-out" before another PC can use the same Special Application. The "Time-out" period may be up to 3 minutes.



**If an application still cannot function correctly, try using the "DMZ" feature.**

## DMZ

- The "DMZ" PC will receive all "Unknown" connections and data. This feature is normally used with applications which do not usually work when behind a Firewall.
- The DMZ PC is effectively outside the Firewall, making it more vulnerable to attacks. For this reason, you should only enable the DMZ feature when required.
- If Enabled, you must select the PC to be used as the "DMZ" PC.

Select the desired option

- **Disabled** - DMZ is disabled.
- **Enabled**- The selected PC will receive any "unknown" connections and data, as described above.

## Multi-DMZ

This feature is only available if your ISP has allocated you multiple Internet IP addresses.

If you have multiple Internet IP addresses, you can assign one DMZ PC for each Internet IP address.

- The "DMZ PC" will receive all "Unknown" connections and data received for the Internet IP address associated with it.

- All outgoing traffic from the DMZ PC will be assigned the WAN IP address associated with it, rather than the shared IP address on the WAN port. Note that **ONLY** the DMZ PC will use the WAN (Internet) IP address you enter on this screen.

Enable	WAN IP address	PC
<input type="checkbox"/>	0 . 0 . 0 . 0	Select a PC
<input type="checkbox"/>	0 . 0 . 0 . 0	Select a PC
<input type="checkbox"/>	0 . 0 . 0 . 0	Select a PC
<input type="checkbox"/>	0 . 0 . 0 . 0	Select a PC
<input type="checkbox"/>	0 . 0 . 0 . 0	Select a PC
<input type="checkbox"/>	0 . 0 . 0 . 0	Select a PC

[My PC is not listed](#)

Save Cancel

Help Close

To use this feature:

- Enter an IP address allocated to you by your ISP into the **WAN IP address** field.
- Select the **PC** to be the DMZ PC for traffic sent to this IP address.
- **Enable** this DMZ.



The "DMZ PC" is effectively outside the Firewall, making it more vulnerable to attacks. For this reason, you should only enable the DMZ feature when required.

## URL Filter

The URL Filter allows you to block access to undesirable Web site

- To use this feature, you must define "filter strings". If the "filter string" appears in a requested URL, the request is blocked.
- Enabling the *URL Filter* also affects the *Internet Access Log*. If Enabled, the "Destination" field in the log will display the URL. Otherwise, it will display the IP Address.

### URL Filter Screen

Click the "URL Filter" on the *Advanced* screen to access the *URL Filter* screen. An example screen is shown below.

**Figure 33: URL Filter Screen**

### Data - URL Filter Screen

Settings	
<b>Enable</b>	This lists any existing entries. If you have not entered any values, this list will be empty.
<b>Schedule</b>	If you always want filtering to be active, select "Always". Otherwise, select the schedule to use. You can define the schedule using the <i>Schedule</i> menu option, on the <i>Advanced</i> menu.
<b>Apply Filter to</b>	Select the groups you wish the filter to apply to. Group membership can be set on the "User Groups" screen, on the "Administration" menu.
Filter Strings	
<b>Filter Strings</b>	This lists any existing entries. If you have not entered any values, this list will be empty.
<b>Delete</b>	Use this to delete the selected entry or entries, as required. Multiple entries can be selected by holding down the CTRL key while selecting. (On the Macintosh, hold the SHIFT key while selecting.)
<b>Delete All</b>	Use this button to delete all entries, if required.

<b>Add Filter</b>	
<b>Filter String</b>	To add an entry to the list, enter it here, and click the "Add" button. An entry may be a Domain name (e.g. www.trash.com) or simply a string (e.g. ads/ ) Any URL which contains ANY entry ANYWHERE in the URL will be blocked.
<b>Add Button</b>	Use this to add the entry in the "Filter String" above to the list.
<b>Add Filter</b>	
<b>Delete/Delete All</b>	Use these buttons to delete the selected entry or all entries, as required. Multiple entries can be selected by holding down the CTRL key while selecting.(On the Macintosh, hold the SHIFT key while selecting.)
<b>Add</b>	Use this to add the current Filter String to the site list.

## Define Schedule

The schedule can be used for the **Access Control** and **URL Filter** features.

- Two (2) separate sessions or periods can be defined.
- Times must be entered using a 24 hr clock.
- If the time for a particular day is blank, no action will be performed.

**Default Schedule**
HELP

Use 24 hour clock.      On all day: 00:00 to 24:00  
Off all day: All fields blank

Day	Session 1		Session 2	
	Start	Finish	Start	Finish
Monday	<input type="text"/>	<input type="text"/>	<input type="text"/>	<input type="text"/>
Tuesday	<input type="text"/>	<input type="text"/>	<input type="text"/>	<input type="text"/>
Wednesday	<input type="text"/>	<input type="text"/>	<input type="text"/>	<input type="text"/>
Thursday	<input type="text"/>	<input type="text"/>	<input type="text"/>	<input type="text"/>
Friday	<input type="text"/>	<input type="text"/>	<input type="text"/>	<input type="text"/>
Saturday	<input type="text"/>	<input type="text"/>	<input type="text"/>	<input type="text"/>
Sunday	<input type="text"/>	<input type="text"/>	<input type="text"/>	<input type="text"/>

**Figure 34: Define Schedule Screen**

### Data – Define Schedule Screen

<b>Day</b>	Each day of the week can scheduled independently.
<b>Session 1</b> <b>Session 2</b>	Two (2) separate sessions or periods can be defined. Session 2 can be left blank if not required.
<b>Start Time</b>	Enter the start using a 24 hr clock.
<b>Finish Time</b>	Enter the finish time using a 24 hr clock.

## User Groups

User Groups are used by the **Access Control** and the **URL Filter** features.

- Groups are pre-named "Default", "Group 1", "Group 2", "Group 3" and "Group 4", and cannot be renamed.
- All PCs are in the "Default" group, unless moved to another group.
- A PC can be a member of 1 group only.
- PCs must be in the "PC Database". If required, you can manually add PCs to the PC Database, using the *PC Database* option on the *Administration* menu.



Figure 35: User Groups Screen

### Data – User Groups Screen

<b>Group List</b>	Select the desired Group. The screen will update to display the PCs for the selected Group.
<b>Group Members</b>	This lists all PCs, which are currently members of the selected group.
<b>Other PCs</b>	This lists all other PCs – those, which are not currently members of the selected group.
<b>Del &gt;&gt;</b>	Use this button to remove members from the current Group. Select the members you wish to delete from this group, and click this button. (Members can not be deleted from the "Default" group.)
<b>&lt;&lt; Add</b>	Use this button to add members to the current Group. In the "Other PCs" list, select the members you wish to add to this group, and click this button. The PCs will be moved from their existing group to the current group.



PCs not assigned to any group will be in the "Default" group.  
PCs deleted from any other Group will be added to the "Default" group.



## Virtual Servers

This feature, sometimes called *Port Forwarding*, allows you to make Servers on your LAN accessible to Internet users. Normally, Internet users would not be able to access a server on your LAN because:

- Your Server does not have a valid external IP Address.
- Attempts to connect to devices on your LAN are blocked by the firewall in this device.

The "Virtual Server" feature solves these problems and allows Internet users to connect to your servers, as illustrated below.

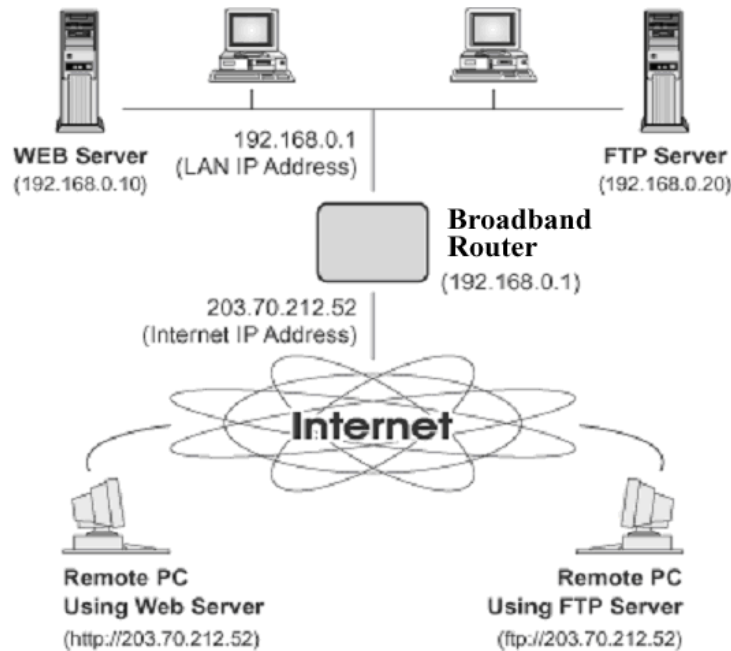

Figure 36: Virtual Servers

### IP Address seen by Internet Users

Note that, in this illustration, both Internet users are connecting to the same IP Address, but using different protocols.

**To Internet users, all virtual Servers on your LAN have the same IP Address. This IP Address is allocated by your ISP.**

This address should be static, rather than dynamic, to make it easier for Internet users to connect to your Servers.

However, you can use the *DDNS (Dynamic DNS)* feature to allow users to connect to your Virtual Servers using a URL, instead of an IP Address.

### Virtual Servers Screen

The *Virtual Servers* screen is reached by the *Virtual Servers* link on the *Advanced* screen. An example screen is shown below.

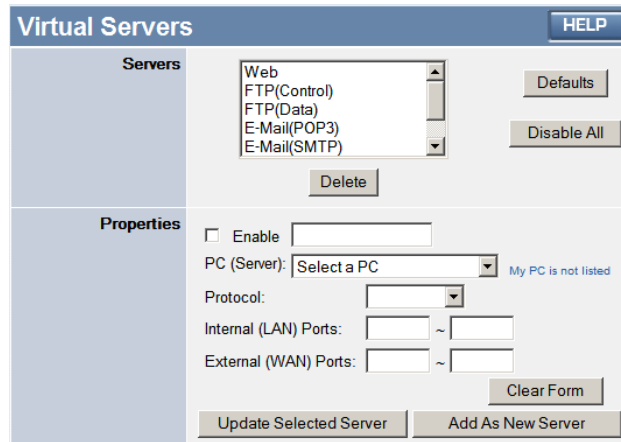

**Figure 37: Virtual Servers Screen**

This screen lists a number of pre-defined Servers, and allows you to define your own Servers. Details of the selected Server are shown in the "Properties" area.

**Data - Virtual Servers Screen**

Servers	
<b>Servers</b>	This lists a number of pre-defined Servers, plus any Servers you have defined. Details of the selected Server are shown in the "Properties" area.
Properties	
<b>Enable</b>	Use this to Enable or Disable support for this Server, as required. <ul style="list-style-type: none"> <li>• If Enabled, any incoming connections will be forwarded to the selected PC.</li> <li>• If Disabled, any incoming connection attempts will be blocked.</li> </ul>
<b>PC (Server)</b>	Select the PC for this Server. The PC must be running the appropriate Server software.
<b>Protocol</b>	Select the protocol (TCP or UDP) used by the Server.
<b>Internal Ports</b>	Enter the range of port numbers which the Server software is configured to use. If only 1 port number is required, enter it in both the start and finish fields.
<b>External Ports</b>	The port numbers used by Internet users when connecting to the Server. These are normally the same as the Internal Port Numbers. If it is different, this device will perform a "mapping" or "translation" function, allowing the server to use one port address, while clients use a different port address.
Buttons	
<b>Defaults</b>	This will delete any Servers you have defined, and set the pre-defined Servers to use their default port numbers.
<b>Disable All</b>	This will cause the "Enable" setting of all Virtual Servers to be set OFF.
<b>Update Selected Server</b>	Update the current Virtual Server entry, using the data shown in the "Properties" area on screen.

<b>Add as new Server</b>	Add a new entry to the Virtual Server list, using the data shown in the "Properties" area on screen. The entry selected in the list is ignored, and has no effect.
<b>Delete</b>	Delete the current Virtual Server entry. Note that the pre-defined Servers can not be deleted. Only Servers you have defined yourself can be deleted.
<b>Clear Form</b>	Clear all data from the "Properties" area, ready for input of a new Virtual Server entry.



**For each entry, the PC must be running the appropriate Server software.**

## Defining your own Virtual Servers

If the type of Server you wish to use is not listed on the *Virtual Servers* screen, you can define and manage your own Servers:

- Create a new Server:**
1. Click "Clear Form"
  2. Enter the required data, as described above.
  3. Click "Add".
  4. The new Server will now appear in the list.
- Modify (Edit) a Server:**
1. Select the desired Server from the list
  2. Make any desired changes (for example, change the Enable/Disable setting).
  3. Click "Update" to save changes to the selected Server.
- Delete a Server:**
1. Select the entry from the list.
  2. Click "Delete".

**Note:** You can only delete Servers you have defined. Pre-defined Server cannot be deleted.



**From the Internet, ALL Virtual Servers have the IP Address allocated by your ISP.**

## Connecting to the Virtual Servers

Once configured, anyone on the Internet can connect to your Virtual Servers. They must use the Internet IP Address (the IP Address allocated to you by your ISP).

e.g.

`http://203.70.212.52`

`ftp://203.70.212.52`

It is more convenient if you are using a Fixed IP Address from your ISP, rather than Dynamic. However, you can use the *Dynamic DNS* feature, described in the following section, to allow users to connect to your Virtual Servers using a URL, rather than an IP Address.

## WAN Port Configuration

The *WAN Port* option is on the *Advanced* menu.

**Figure 38: WAN Port Screen**

### Data – WAN Port Screen

Port Settings	
<b>Port Speed</b>	Normally, this can be left at "Automatic". If the device attached to the WAN Port has problems making a connection, you can select the setting required or preferred by the other device.
<b>MTU Size</b>	<ul style="list-style-type: none"> <li>• MTU (Maximum Transmission Unit) value should only be changed if advised to do so by Technical Support.</li> <li>• Enter a value between 1 and 1500.</li> <li>• This device will still auto-negotiate with the remote server, to set the MTU size. The smaller of the 2 values (auto-negotiated, or entered here) will be used.</li> <li>• For direct connections (not PPPoE or PPTP), the MTU used is always 1500.</li> </ul>
Identification	
<b>Hostname</b>	Normally, there is no need to change the default name, but if your ISP requests that you use a particular Hostname, enter it here.
<b>Domain Name</b>	If your ISP provided a domain name, enter it here. Otherwise, this may be left blank.
<b>WAN Port MAC Address</b>	<p>Also called <i>Network Adapter Address</i> or <i>Physical Address</i>. This is a low-level identifier, as seen from the WAN port.</p> <p>Normally there is no need to change this, but some ISPs require a particular value, often that of the PC initially used for Internet access.</p> <p>You can use the <i>Copy from PC</i> button to copy your PC's address into this field, the <i>Default</i> button to insert the default value, or enter a value directly.</p>

IP Address	
<b>Automatic</b>	Also called Dynamic IP Address. This is the default, and the most common. Leave this selected if your ISP allocates an IP Address to the Broadband Router upon connection.
<b>Specified IP Address</b>	Also called Static IP Address. Select this if your ISP has allocated you a fixed IP Address. If this option is selected, the following data must be entered. <ul style="list-style-type: none"> <li>• <b>IP Address</b> The IP Address allocated by the ISP.</li> <li>• <b>Network Mask (Not required for PPPoE)</b> This is also supplied by your ISP. It must be compatible with the IP Address above.</li> <li>• <b>Gateway IP Address (Not required for PPPoE)</b> The address of the router or gateway, as supplied by your ISP.</li> </ul>
DNS	
<b>Automatically obtain from Server</b>	The DNS (Domain Name Server) address will be obtained automatically from your ISP's server. Note that if using a fixed IP address, with no login (login is set to "None"), then no Server is used, so this option cannot be used.
<b>Use this DNS</b>	If this option is selected, you must enter the IP address of the DNS (Domain Name Server) you wish to use.
Login	
<b>Login Method</b>	If your ISP does not use a login method (username, password) for Internet access, leave this at the default value <b>None (Direct connection)</b> . Otherwise, check the documentation from your ISP, select the login method used, and enter the required data. <ul style="list-style-type: none"> <li>• <b>PPPoE</b> - this is the most common login method, widely used with DSL modems. Normally, your ISP will have provided some software to connect and login. This software is no longer required, and should not be used.</li> <li>• <b>PPPoE (Unnumbered IP)</b> - this can only be used if your ISP supports this system, and has allocated you multiple IP addresses. If selected, you must also select "Specified IP Address" above and enter one of the IP addresses allocated to you by your ISP. The other IP addresses must be assigned to PCs on your LAN.</li> <li>• <b>PPTP</b> - this is mainly used in Europe. You need to know the PPTP Server address as well as your name and password.</li> <li>• <b>L2TP</b> - this is not widely used. You need to know the PPTP Server address as well as your name and password.</li> <li>• <b>Big Pond Cable</b> - for Australia only.</li> <li>• <b>SingTel RAS</b> - for Singapore only.</li> </ul>
<b>Login User Name</b>	The User Name (or account name) provided by your ISP.
<b>Login Password</b>	Enter the password for the login name above.
<b>RAS Plan</b>	For SingTel customers only, select the RAS plan you are on.

<b>Server Address</b>	This is not required for PPPoE or SingTel RAS. For PPTP, L2TP and BPA, enter the Server address as provided by your ISP.
<b>Connection Behavior</b>	Select the desired option: <ul style="list-style-type: none"> <li>• <b>Automatic Connect/Disconnect</b> An Internet connection is automatically made when required, and disconnected when idle for the time period specified by the "Auto-disconnect Idle Time-out".</li> <li>• <b>Manual Connect/Disconnect</b> You must manually establish and terminate the connection.</li> <li>• <b>Keep alive (maintain connection)</b> The connection will never be disconnected by this device. If disconnected by your ISP, the connection will be re-established immediately. (However, this does not ensure that your Internet IP address will remain unchanged.)</li> </ul>
<b>Auto-disconnect Idle Time-out</b>	This field has no effect unless using the <b>Automatic Connect/Disconnect</b> setting. If using this setting, enter the desired idle time-out period (in minutes). After the connection to your ISP has been idle for this time period, the connection will be terminated.
<b>Buttons</b>	
<b>Default</b>	Inserts the default MAC address into the MAC address field. You must click "Save" to actually change the address used.
<b>Copy from PC</b>	Inserts the MAC address from your PC into the MAC address field. You must click "Save" to actually change the address used.
<b>Save</b>	Save your changes to the Broadband Router.
<b>Cancel</b>	Reverse any changes made since the last "Save".

## Chapter 7

# Advanced Administration

*This Chapter explains the settings available via the "Administration" section of the menu.*

## Overview

Normally, it is not necessary to use these screens, or change any settings. These screens and settings are provided to deal with non-standard situations, or to provide additional options for advanced users.

The available settings and features are:

- Config File** Backup or restore the configuration file for the Broadband Router This file contains all the configuration data.
- Logs** View or clear all logs, set E-Mailing of log files.

<b>Network Diagnostics</b>	Ping, DNS Lookup.
<b>Options</b>	Various options, such as backup DNS, UPnP, and enable TFTP firmware upgrade option.
<b>PC Database</b>	This is the list of PCs shown when you select the "DMZ PC" or a "Virtual Server". This database is maintained automatically, but you can add and delete entries for PCs which use a Fixed (Static) IP Address.
<b>Remote Administration</b>	Allow settings to be changed from the Internet..
<b>Routing</b>	Only required if your LAN has other Routers or Gateways.
<b>Security</b>	Firewall and other security-related settings. Normally, the default settings do not need to be changed.
<b>Firmware Upgrade</b>	Upgrade the Firmware (software) installed in your Broadband Router.

## Config File

This feature allows you to download the current settings from the Broadband Router, and save them to a file on your PC.

You can restore a previously-downloaded configuration file to the Broadband Router, by uploading it to the Broadband Router.

This screen also allows you to set the Broadband Router back to its factory default configuration. Any existing settings will be deleted.

An example *Config File* screen is shown below.

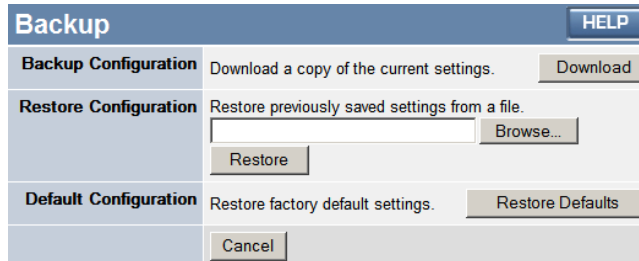

Figure 39: Config Screen

### Data - Config File Screen

<b>Backup Config</b>	Use this to download a copy of the current configuration, and store the file on your PC. Click <i>Download</i> to start the download.
<b>Restore Config</b>	<p>This allows you to restore a previously-saved configuration file back to the Broadband Router</p> <p>Click <i>Browse</i> to select the configuration file, then click <i>Restore</i> to upload the configuration file.</p> <p><b>WARNING !</b></p> <p>Uploading a configuration file will destroy (overwrite) ALL of the existing settings.</p>
<b>Default Config</b>	<p>Clicking the <i>Restore Defaults</i> button will reset the Broadband Router to its factory default settings.</p> <p><b>WARNING !</b></p> <p>This will delete ALL of the existing settings.</p>



## Logs

The Logs record various types of activity on the Broadband Router. This data is useful for troubleshooting, but enabling all logs will generate a large amount of data and adversely affect performance.

Since only a limited amount of log data can be stored in the Broadband Router, log data can also be E-mailed to your PC.

Figure 40: Logs Screen

### Data - Logs Screen

Enable Logs	
<b>Outgoing Connections</b>	If selected, Outgoing Internet connections are logged. Normally, the (Internet) "Destination" will be shown as an IP address. But if the "URL Filter" is enabled, the "Destination" will be shown as a URL.
<b>Access Control</b>	If enabled, the log will include attempted outgoing connections which have been blocked by the "Access Control" feature.
<b>DoS Attacks</b>	If enabled, this log will show details of DoS (Denial of Service) attacks which have been blocked by the built-in Firewall.
<b>Timezone</b>	Select the correct Timezone for your location. This is required for the date/time shown on the logs to be correct.
<b>View Log Button</b>	Use this to view each log, as required.
<b>Clear Log Button</b>	Use this to restart the required log. This makes it easier to read the latest entries.
E-Mail Alerts	
<b>Send E-mail alert..</b>	If enabled, an E-mail will be sent immediately if a DoS (Denial of Service) attack is detected. If enabled, the E-mail address information (below) must be provided.

<b>E-Mail Logs</b>	
<b>Send Logs</b>	<p>Select the desired option for sending the log by E-mail.</p> <ul style="list-style-type: none"> <li>• <b>Never</b> - E-mailing of Logs is disabled.</li> <li>• <b>When log is full</b> - The time is not fixed. The log will be sent when the log is full, which will depend on the volume of traffic.</li> <li>• <b>Every day, Every Monday ...</b> - The log is sent on the interval specified. <ul style="list-style-type: none"> <li>• If "Every day" is selected, the log is sent at the time specified.</li> <li>• If the day is specified, the log is sent once per week, on the specified day.</li> <li>• Select the time of day you wish the E-mail to be sent.</li> <li>• If the log is full before the time specified to send it, it will be sent regardless.</li> </ul> </li> </ul>
<b>Include</b>	<p>Enabled the logs you wish to send. If no checkboxes are enabled, no logs will be sent.</p> <p>For each type of log, you can set the "Subject" field which is displayed in your inbox when you receive the mail.</p>
<b>E-mail Subject</b>	<p>For each type of log, you can set the "Subject" field which is displayed in your inbox when you receive the mail.</p>
<b>E-Mail Address</b>	
<b>E-mail Address</b>	<p>Enter the E-mail address the Log is to be sent to. The E-mail will also show this address as the Sender's address.</p>
<b>SMTP Server Address</b>	<p>Enter the address (domain name) or IP address of the SMTP (Simple Mail Transport Protocol) Server you use for outgoing E-mail.</p>
<b>Port No.</b>	<p>Enter the port number used to connect to the SMTP Server. The default value is 25.</p>
<b>Server requires Login to send mail</b>	<p>If your SMTP Server requires you to login in order to send mail:</p> <ul style="list-style-type: none"> <li>• Check the setting "Server requires login to send mail"</li> <li>• Enter your <b>Login Name</b> and <b>Password</b> for the SMTP Server in the fields provided.</li> </ul>

## Network Diagnostics

This screen allows you to perform a "Ping" or a "DNS lookup". These activities can be useful in solving network problems.

An example *Network Diagnostics* screen is shown below.

Figure 41: Network Diagnostics Screen

### Data - Network Diagnostics Screen

Ping	
<b>Ping this IP Address</b>	Enter the IP address you wish to ping. The IP address can be on your LAN, or on the Internet. Note that if the address is on the Internet, and no connection currently exists, you could get a "Timeout" error. In that case, wait a few seconds and try again.
<b>Ping Button</b>	After entering the IP address, click this button to start the "Ping" procedure. The results will be displayed in the <i>Ping Results</i> pane.
DNS Lookup	
<b>Domain name/URL</b>	Enter the Domain name or URL for which you want a DNS (Domain Name Server) lookup. Note that if the address is on the Internet, and no connection currently exists, you could get a "Timeout" error. In that case, wait a few seconds and try again.
<b>Lookup Button</b>	After entering the Domain name/URL, click this button to start the "DNS Lookup" procedure. The results will be displayed in the <i>DNS Lookup Results</i> pane.

## Options

This screen allows advanced users to enter or change a number of settings. For normal operation, there is no need to use this screen or change any settings.

An example *Options* screen is shown below.

The screenshot shows a web interface titled "Options" with a "HELP" button in the top right. The interface is divided into two main sections: "Backup DNS" and "UPnP".

**Backup DNS:** This section contains two input fields for "Backup DNS (1) IP Address" and "Backup DNS (2) IP Address", each with four boxes for the octets. Below these fields is a note: "These DNS (Domain Name Servers) are used only if the primary DNS is unavailable."

**UPnP:** This section contains three checkboxes:
 

- Enable UPnP Services
- Allow configuration changes through UPnP
- Allow Internet access to be disabled

At the bottom of the form are "Save" and "Cancel" buttons.

**Figure 42: Options Screen**

### Data - Options Screen

Backup DNS	
<b>IP Address</b>	Enter the IP Address of the DNS (Domain Name Servers) here. These DNS will be used only if the primary DNS is unavailable.
UPnP	
<b>Enable UPnP Services</b>	<ul style="list-style-type: none"> <li>• UPnP (Universal Plug and Play) allows automatic discovery and configuration of equipment attached to your LAN. UPnP is by supported Windows ME, XP, or later.</li> <li>• If Enabled, this device will be visible via UPnP.</li> <li>• If Disabled, this device will not be visible via UPnP.</li> </ul>
<b>Allow Configuration...</b>	<ul style="list-style-type: none"> <li>• If checked, then UPnP users can change the configuration.</li> <li>• If Disabled, UPnP users can only view the configuration.</li> </ul>
<b>Allow Internet access to be disabled</b>	<ul style="list-style-type: none"> <li>• If checked, then UPnP users can disable Internet access via this device.</li> <li>• If Disabled, UPnP users can NOT disable Internet access via this device.</li> </ul>

## PC Database

The PC Database is used whenever you need to select a PC (e.g. for the "DMZ" PC). It eliminates the need to enter IP addresses. Also, you do not need to use fixed IP addresses on your LAN.

### PC Database Screen

An example *PC Database* screen is shown below.

**Figure 43: PC Database**

- PCs which are "DHCP Clients" are automatically added to the database, and updated as required.
- By default, non-Server versions of Windows act as "DHCP Clients"; this setting is called "Obtain an IP Address automatically".
- The Broadband Router uses the "Hardware Address" to identify each PC, not the name or IP address. The "Hardware Address" can only change if you change the PC's network card or adapter.
- This system means you do NOT need to use Fixed (static) IP addresses on your LAN. However, you can add PCs using Fixed (static) IP Addresses to the PC database if required.

**Data - PC Database Screen**

<b>Known PCs</b>	This lists all current entries (PCs or network devices).
<b>Name</b>	If adding a new PC to the list, enter its name here. It is best if this matches the PC's "hostname".
<b>IP Address</b>	If adding a new PC to the list, enter the IP Address of the PC here. The PC will be sent a "ping" to determine its hardware address. If the PC is not available (not connected, or not powered On) you will not be able to add it.
<b>Buttons</b>	
<b>Add</b>	This will add the new PC to the list. The PC will be sent a "ping" to determine its hardware address. If the PC is not available (not connected, or not powered On) you will not be able to add it.
<b>Delete</b>	Delete the selected PC from the list. This should be done in 2 situations: <ul style="list-style-type: none"> <li>• The PC has been removed from your LAN.</li> <li>• The entry is incorrect.</li> </ul>
<b>Refresh</b>	Update the data on screen.
<b>Generate Report</b>	Display a read-only list showing full details of all entries in the PC database.
<b>Advanced Administration</b>	Click this to view the advanced "PC Database" screen.

## PC Database (Admin)

This screen is displayed if the "Advanced Administration" button on the *PC Database* is clicked. It provides more control than the standard *PC Database* screen.

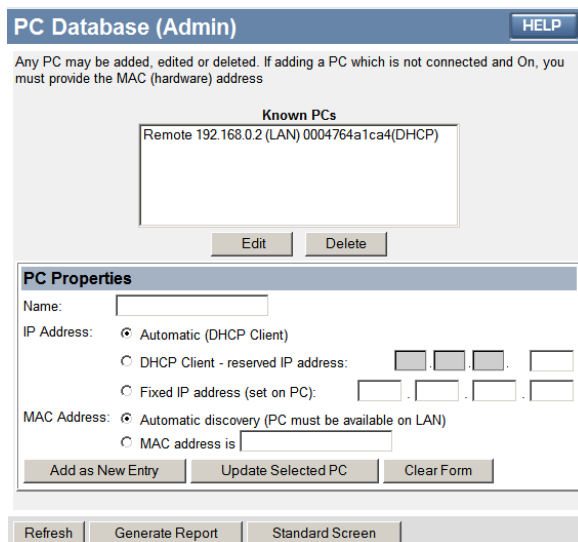

Figure 44: PC Database (Admin)

### Data - PC Database ( Admin) Screen

<b>Known PCs</b>	This lists all current entries. Data displayed is <i>name (IP Address) type</i> . The "type" indicates whether the PC is connected to the LAN.
<b>Edit</b>	Use this to change the data for the selected PC in the list. The data for the selected PC will then be shown in the "Properties" area, where it may be edited. (Click "Update" to save any changes.)
<b>Delete</b>	Use this to Delete the selected PC from the list. This should be done in 2 situations: <ul style="list-style-type: none"> <li>• The PC has been removed from your LAN.</li> <li>• The entry is incorrect.</li> </ul>

PC Properties	
<b>Name</b>	If adding a new PC to the list, enter its name here. It is best if this matches the PC's "hostname".
<b>IP Address</b>	Select the appropriate option: <ul style="list-style-type: none"> <li>• <b>Automatic</b> - The PC is set to be a DHCP client (Windows: "Obtain an IP address automatically"). The Broadband Router will allocate an IP address to this PC when requested to do so. The IP address could change, but normally won't.</li> <li>• <b>DCHP Client - Reserved IP Address</b> - Select this if the PC is set to be a DCHP client, and you wish to guarantee that the Broadband Router will always allocate the same IP Address to this PC. Enter the required IP address. Only the last field is required; the other fields must match the Broadband Router's IP address.</li> <li>• <b>Fixed IP Address</b> - Select this if the PC is using a Fixed (Static) IP address. Enter the IP address allocated to the PC. (The PC must be configured to use this IP address.)</li> </ul>

<b>MAC Address</b>	<p>Select the appropriate option</p> <ul style="list-style-type: none"> <li>• <b>Automatic discovery</b> - Select this to have the Broadband Router contact the PC and find its MAC address. This is only possible if the PC is connected to the LAN and powered On.</li> <li>• <b>MAC is</b> - Enter the MAC address on the PC. The MAC address is also called the "Hardware Address", "Physical Address", or "Network Adapter Address". The Broadband Router uses this to provide a unique identifier for each PC. Because of this, the MAC address can NOT be left blank.</li> </ul>
<b>Buttons</b>	
<b>Add as New Entry</b>	<p>Add a new PC to the list, using the data in the "Properties" box. If "Automatic discovery" (for MAC address) is selected, the PC will be sent a "ping" to determine its hardware address. This will fail unless the PC is connected to the LAN, and powered on.</p>
<b>Update Selected PC</b>	<p>Update (modify) the selected PC, using the data in the "Properties" box.</p>
<b>Clear Form</b>	<p>Clear the "Properties" box, ready for entering data for a new PC.</p>
<b>Refresh</b>	<p>Update the data on screen.</p>
<b>Generate Report</b>	<p>Display a read-only list showing full details of all entries in the PC database.</p>
<b>Standard Screen</b>	<p>Click this to view the standard <i>PC Database</i> screen.</p>



## Remote Admin

If enabled, this feature allows you to manage the Broadband Router via the Internet.

Figure 45: Remote Administration Screen

### Data - Remote Administration Screen

Remote Administration	
<b>Enable Remote Management</b>	Enable to allow management via the Internet. If Disabled, this device will ignore management connection attempts from the Internet.
<b>Port Number</b>	<p>Enter a port number between 1024 and 65535. The default for HTTP (Web) connections is port 80, but using port 80 will prevent the use of a Web "Virtual Server" on your LAN. So using a different port number is recommended. The default value is 8080.</p> <p>The port number must be specified in your Browser when you connect. To specify the port number :</p> <ol style="list-style-type: none"> <li>From a remote location, start your Browser.</li> <li>In the "Address" or "Location" field, enter the <b>Internet IP</b> address of this device (NOT the LAN IP address), followed by the port number, as follows:  <pre>http://ip_address:port_number</pre> <p>Where:  <b>ip_address</b> is the Internet IP address of this device.  <b>port_number</b> is the port number assigned on this screen.</p> </li> <li>You should then be prompted for the password for this device. (You must assign a password!)</li> </ol>
<b>Current IP Address</b>	<p>To manage this device via the Internet, you need to know the IP Address of this device, as seen from the Internet. This IP Address is allocated by your ISP, and is shown here. But if using a Dynamic IP Address, this value can change each time you connect to your ISP. There are 2 solutions to this problem:</p> <ul style="list-style-type: none"> <li>Have your ISP allocate you a Fixed IP address.</li> <li>Use the DDNS feature (Advanced menu) so you can connect using a Domain Name, rather than an IP address.</li> </ul>

### To connect from a remote PC via the Internet

- Ensure your Internet connection is established, and start your Web Browser.
- In the "Address" bar, enter "HTTP://" followed by the Internet IP Address of the Broadband Router. If the port number is not 80, the port number is also required. (After the IP Address, enter ":" followed by the port number.)  
e.g.

HTTP://123.123.123.123:8080

This example assumes the WAN IP Address is 123.123.123.123, and the port number is 8080.

## Routing

### Overview

- If you don't have other Routers or Gateways on your LAN, you can ignore the "Routing" page completely.
- If the Broadband Router is only acting as a Gateway for the local LAN segment, ignore the "Routing" page even if your LAN has other Routers.
- If your LAN has a standard Router (e.g. Cisco) on your LAN, and the Broadband Router is to act as a Gateway for all LAN segments, enable RIP (Routing Information Protocol) and ignore the Static Routing table.
- If your LAN has other Gateways and Routers, and you wish to control which LAN segments use each Gateway, do NOT enable RIP (Routing Information Protocol). Configure the Static Routing table instead. (You also need to configure the other Routers.)
- If using Windows 2000 Data center Server as a software Router, enable RIP on the Broadband Router, and ensure the following Windows 2000 settings are correct:
  - Open *Routing and Remote Access*
  - In the console tree, select *Routing and Remote Access*, *[server name]*, *IP Routing*, *RIP*
  - In the "Details" pane, right-click the interface you want to configure for RIP version 2, and then click "Properties".
  - On the "General" tab, set *Outgoing packet protocol* to "RIP version 2 broadcast", and *Incoming packet protocol* to "RIP version 1 and 2".

### Routing Screen

The routing table is accessed by the *Routing* link on the *Administration* menu.

#### Using this Screen

Generally, you will use either RIP (Routing Information Protocol) OR the Static Routing Table, as explained above, although it is possible to use both methods simultaneously.

#### Static Routing Table

- If RIP is not used, an entry in the routing table is required for each LAN segment on your Network, other than the segment to which this device is attached.
- The other Routers must also be configured. See *Configuring Other Routers on your LAN* later in this chapter for further details and an example.

Figure 46: Routing Screen

## Data - Routing Screen

RIP	
<b>Enable RIP V1</b>	Check this to enable the RIP (Routing Information Protocol) feature of the Broadband Router  The Broadband Router supports RIP 1 only.
Static Routing	
<b>Static Routing Table Entries</b>	This list shows all entries in the Routing Table. <ul style="list-style-type: none"> <li>The "Properties" area shows details of the selected item in the list.</li> <li>Change any the properties as required, then click the "Update" button to save the changes to the selected entry.</li> </ul>
<b>Properties</b>	<ul style="list-style-type: none"> <li><b>Destination Network</b> - The network address of the remote LAN segment. For standard class "C" LANs, the network address is the first 3 fields of the Destination IP Address. The 4th (last) field can be left at 0.</li> <li><b>Network Mask</b> - The Network Mask for the remote LAN segment. For class "C" networks, the default mask is 255.255.255.0</li> <li><b>Gateway IP Address</b> - The IP Address of the Gateway or Router which the Broadband Router must use to communicate with the destination above. (NOT the router attached to the remote segment.)</li> <li><b>Metric</b> - The number of "hops" (routers) to pass through to reach the remote LAN segment. The shortest path will be used. The default value is 2.</li> </ul>
Buttons	
<b>Save</b>	Save the RIP setting. This has no effect on the Static Routing Table.
<b>Add</b>	Add a new entry to the Static Routing table, using the data shown in the "Properties" area on screen. The entry selected in the list is ignored, and has no effect.
<b>Update</b>	Update the current Static Routing Table entry, using the data shown in the "Properties" area on screen.
<b>Delete</b>	Delete the current Static Routing Table entry.
<b>Clear Form</b>	Clear all data from the "Properties" area, ready for input of a new entry for the Static Routing table.
<b>Generate Report</b>	Generate a read-only list of all entries in the Static Routing table.

## Configuring Other Routers on your LAN

It is essential that all IP packets for devices not on the local LAN be passed to the Broadband Router, so that they can be forwarded to the external LAN, WAN, or Internet. To achieve this, the local LAN must be configured to use the Broadband Router as the *Default Route* or *Default Gateway*.

### Local Router

The local router is the Router installed on the same LAN segment as the Broadband Router. This router requires that the *Default Route* is the Broadband Router itself. Typically, routers have a special entry for the *Default Route*. It should be configured as follows.

<b>Destination IP Address</b>	Normally 0.0.0.0, but check your router documentation.
<b>Network Mask</b>	Normally 0.0.0.0, but check your router documentation.
<b>Gateway IP Address</b>	The IP Address of the Broadband Router.
<b>Metric</b>	2

### Other Routers on the Local LAN

Other routers on the local LAN must use the Broadband Router's *Local Router* as the *Default Route*. The entries will be the same as the Broadband Router's local router, with the exception of the *Gateway IP Address*.

- For a router with a direct connection to the Broadband Router's local Router, the *Gateway IP Address* is the address of the Broadband Router's local router.
- For routers which must forward packets to another router before reaching the Broadband Router's local router, the *Gateway IP Address* is the address of the intermediate router.

### Static Routing - Example

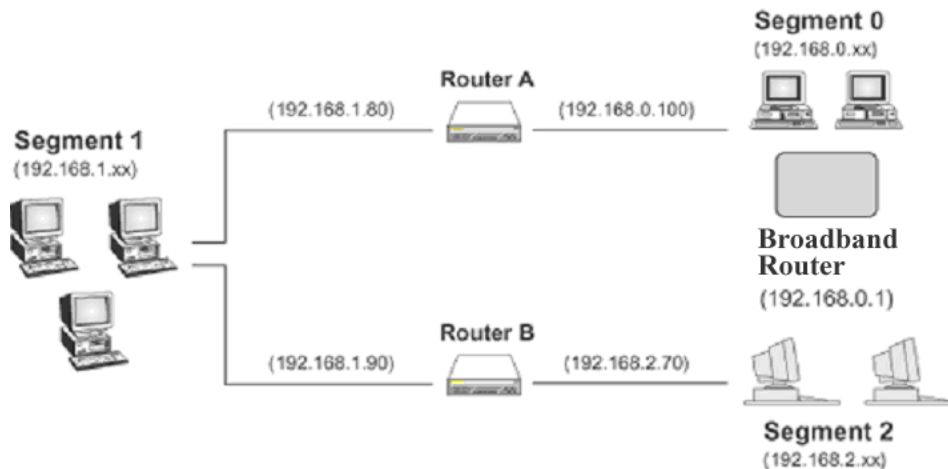

Figure 47: Routing Example

### For the Broadband Router's Routing Table

For the LAN shown above, with 2 routers and 3 LAN segments, the Broadband Router requires 2 entries as follows.

<b>Entry 1 (Segment 1)</b>	
Destination IP Address	192.168.1.0
Network Mask	255.255.255.0 (Standard Class C)
Gateway IP Address	192.168.0.100 (Broadband Router's local Router)
Metric	2
<b>Entry 2 (Segment 2)</b>	
Destination IP Address	192.168.2.0
Network Mask	255.255.255.0 (Standard Class C)
Gateway IP Address	192.168.0.100
Metric	3

**For Router A's Default Route**

Destination IP Address	0.0.0.0
Network Mask	0.0.0.0
Gateway IP Address	192.168.0.1 (Broadband Router's IP Address)

**For Router B's Default Route**

Destination IP Address	0.0.0.0
Network Mask	0.0.0.0
Gateway IP Address	192.168.1.80 (Broadband Router's local router)

# Security

This screen allows you to set Firewall and other security-related options.

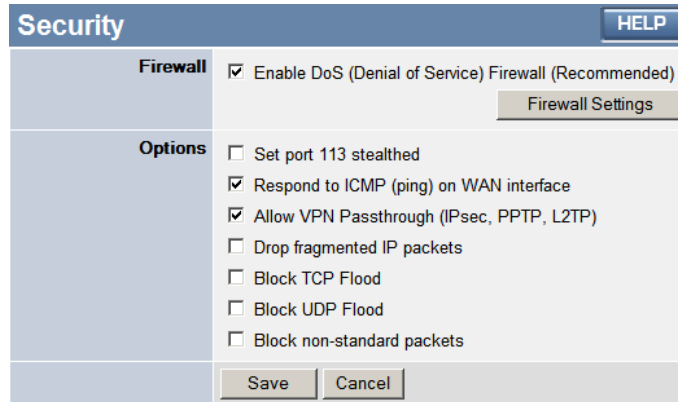

**Figure 48: Security Screen**

## Data - Security Screen

DoS Firewall	
<b>Enable DoS Firewall</b>	<p>If enabled, DoS (Denial of Service) attacks will be detected and blocked. The default is enabled. It is strongly recommended that this setting be left enabled.</p> <p><b>Note:</b></p> <ul style="list-style-type: none"> <li>• A DoS attack does not attempt to steal data or damage your PCs, but overloads your Internet connection so you can not use it - the service is unavailable.</li> <li>• This device uses "Stateful Inspection" technology. This system can detect situations where individual TCP/IP packets are valid, but collectively they become a DoS attack.</li> </ul>
<b>Firewall Settings Button</b>	<p>If you wish to adjust the settings used by the DoS firewall, click this button to open a sub-window.</p>
Options	
<b>Respond to ICMP</b>	<p>The ICMP protocol is used by the "ping" and "traceroute" programs, and by network monitoring and diagnostic programs.</p> <ul style="list-style-type: none"> <li>• If checked, the Broadband Router will repond to ICMP packets received from the Internet.</li> <li>• If not checked, ICMP packets from the Internet will be ignored. Disabling this option provides a slight increase in security.</li> </ul>
<b>Allow VPN Passthrough</b>	<p>The IPSec, PPTP, and L2TP protocols are used to establish a secure connection, and are widely used by VPN (Virtual Private Network) programs.</p> <ul style="list-style-type: none"> <li>• If checked, these VPN connections are allowed.</li> <li>• If not checked, these VPN connections are blocked.</li> </ul> <p>Note: IPSec sessions must NOT use AH (Authentication Header). Packets using AH cannot be routed correctly.</p>
<b>Drop fragmented IP packets</b>	<p>If enabled, fragmented IP packets are discarded, forcing re-transmission of these packets. In some situations, this could prevent successful communication.</p>

<b>Block TCP Flood</b>	A TCP flood is excessively large number of TCP connection requests. This is usually a DoS (Denial of Service) attack. This setting should be normally be enabled.
<b>Block UDP Flood</b>	A UDP flood is excessively large number of UDP packets. This is usually a DoS (Denial of Service) attack. This setting should be normally be enabled.
<b>Block non-standard packets</b>	Abnormal packets are often used by hackers and in DoS attacks, but may also be generated by mis-configured network devices. (PCs will normally not generate non-standard packets.) This setting should normally be enabled.

## Upgrade Firmware



The firmware (software) in the Broadband Router can be upgraded using your Web Browser.

You must first download the upgrade file, then select *Upgrade* on the *Administration* menu. You will see a screen like the following.

Figure 49: Upgrade Firmware Screen

### To perform the Firmware Upgrade:

1. Click the "Browse" button and navigate to the location of the upgrade file.
2. Select the upgrade file. Its name will appear in the *Upgrade File* field.
3. Click the "Start Upgrade" button to commence the firmware upgrade.



**The Broadband Router is unavailable during the upgrade process, and must restart when the upgrade is completed. Any connections to or through the Broadband Router will be lost.**

## Appendix A

# Troubleshooting

*This Appendix covers the most likely problems and their solutions.*

## Overview

This chapter covers some common problems that may be encountered while using the Broadband Router and some possible solutions to them. If you follow the suggested steps and the Broadband Router still does not function properly, contact your dealer for further advice.

## General Problems

**Problem 1:** Can't connect to the Broadband Router to configure it.

**Solution 1:** Check the following:

- The Broadband Router is properly installed, LAN connections are OK, and it is powered ON.
- Ensure that your PC and the Broadband Router are on the same network





segment. (If you don't have a router, this must be the case.)

- If your PC is set to "Obtain an IP Address automatically" (DHCP client), restart it.
- If your PC uses a Fixed (Static) IP address, ensure that it is using an IP Address within the range 192.168.0.2 to 192.168.0.254 and thus compatible with the Broadband Router's default IP Address of 192.168.0.1. Also, the Network Mask should be set to 255.255.255.0 to match the Broadband Router.  
In Windows, you can check these settings by using *Control Panel-Network* to check the *Properties* for the TCP/IP protocol.

## Internet Access

**Problem 1:** When I enter a URL or IP address I get a time out error.

**Solution 1:** A number of things could be causing this. Try the following troubleshooting steps.

- Check if other PCs work. If they do, ensure that your PCs IP settings are correct. If using a Fixed (Static) IP Address, check the Network Mask, Default gateway and DNS as well as the IP Address.
- If the PCs are configured correctly, but still not working, check the Broadband Router. Ensure that it is connected and ON. Connect to it and check its settings. (If you can't connect to it, check the LAN and power connections.)
- If the Broadband Router is configured correctly, check your Internet connection (DSL/Cable modem etc) to see that it is working correctly.

**Problem 2:** Some applications do not run properly when using the Broadband Router.

**Solution 2:** The Broadband Router processes the data passing through it, so it is not transparent.

Use the *Special Applications* feature to allow the use of Internet applications which do not function correctly.

If this does solve the problem you can use the *DMZ* function. This should work with almost every application, but:

- It is a security risk, since the firewall is disabled.
- Only one (1) PC can use this feature.

# Appendix B

## Specifications

### Multi-Function Broadband Router

Model	Broadband Router
-------	------------------

Dimensions	141mm(W) * 100mm(D) * 27mm(H)
Operating Temperature	0° C to 40° C
Storage Temperature	-10° C to 70° C
Network Protocol:	TCP/IP
Network Interface:	5 Ethernet: 4 * 10/100/1000BaseT (RJ45) LAN connection 1 * 10/100/1000BaseT (RJ45) for WAN
LEDs	17
Power Adapter	12 V DC External

## Regulatory Approvals

### CE Standards

This product complies with the 99/5/EEC directives, including the following safety and EMC standards:

- EN301489-1/-17
- EN60950

### CE Marking Warning

This is a Class B product. In a domestic environment this product may cause radio interference in which case the user may be required to take adequate measures.



# TRENDnet<sup>®</sup>

## TRENDnet Technical Support

### US • Canada

**Toll Free Telephone:** 1(866) 845-3673

24/7 Tech Support



### Europe (Germany • France • Italy • Spain • Switzerland • UK)

**Toll Free Telephone:** +00800 60 76 76 67

English/Espanol - 24/7

Francais/Deutsch - 11am-8pm, Monday - Friday MET

### Worldwide

**Telephone:** +[31] [0] 20 504 05 35

English/Espanol - 24/7

Francais/Deutsch - 11am-8pm, Monday - Friday MET

## Product Warranty Registration

Please take a moment to register your product online.

Go to TRENDnet's website at <http://www.trendnet.com/register>

# TRENDnet<sup>®</sup>

20675 Manhattan Place  
Torrance, CA 90501  
USA